

# INSTALLATION MANUAL

## *Ceiling And Floor Type*

*Digital Scroll and DC/AC Inverter Commercial Air-conditioner*

***The Digital Scroll and DC/AC Inverter share the same indoor units.***

Thank you very much for purchasing our air conditioner,  
please read this manual carefully and keep it for future reference.

CONTENTS

PAGE

PRECAUTIONS.....1

INSTALLATION INFORMATION.....2

ATTACHED FITTINGS.....2

INDOOR UNIT INSTALLATION.....3

INSTALL THE CONNECTING PIPE.....5

CONNECT THE DRAIN PIPE.....6

WIRING.....7

CONTROL OPERATION.....8

TEST OPERATION.....11

# 1. PRECAUTIONS

- Be sure to be in conformity with the local, national and international laws and regulations.
- Read "PRECAUTIONS" carefully before installation.
- The following precautions include important safety items. Observe them and never forget.
- Keep this manual with the owner's manual in a handy place for future reference.

The safety precautions listed here are divided into two categories. In either case, important safety information is listed which must be read carefully.



## WARNING

Failure to observe a warning may result in death.



## CAUTION

Failure to observe a caution may result in injury or damage to the equipment.

After completing the installation, make sure that the unit operates properly during the start-up operation. Please instruct the customer on how to operate the unit and keep it maintained. Also, inform customers that they should store this installation manual along with the owner's manual for future reference.



## WARNING

**Be sure only trained and qualified service personnel to install, repair or service the equipment.**

Improper installation, repair, and maintenance may result in electric shocks, short-circuit, leaks, fire or other damage to the equipment.

**Install according to this installation instructions strictly.** If installation is defective, it will cause water leakage, electrical shock and fire.

**When installing the unit in a small room, take measures against to keep refrigerant concentration from exceeding allowable safety limits in the event of refrigerant leakage.** Contact the place of purchase for more information. Excessive refrigerant in a closed ambient can lead to oxygen deficiency.

**Use the attached accessories parts and specified parts for installation.** otherwise, it will cause the set to fall, water leakage, electrical shock and fire.

**Install at a strong and firm location which is able to withstand the set's weight.** If the strength is not enough or installation is not properly done, the set will drop to cause injury.

**The appliance shall not be installed in the laundry.**

**Before obtaining access to terminals, all supply circuits must be disconnected.**

**The appliance must be positioned so that the plug is accessible.**

**The enclosure of the appliance shall be marked by word, or by symbols, with the direction of the fluid flow.**

**For electrical work, follow the local national wiring standard, regulation and this installation instructions. An independent circuit and single outlet must be used.** If electrical circuit capacity is not enough or defect in electrical work, it will cause electrical shock fire.

**Use the specified cable and connect tightly and clamp the cable so that no external force will be acted on the terminal.** If connection or fixing is not perfect, it will cause heat-up or fire at the connection.

**Wiring routing must be properly arranged so that control board cover is fixed properly.** If control board cover is not fixed perfectly, it will cause heat-up at connection point of terminal, fire or electrical shock.

**If the supply cord is damaged, it must be replaced by the manufacture or its service agent or a similarly qualified person in order to avoid a hazard.**

**An all-pole disconnection switch having a contact separation of at least 3mm in all poles should be connected in fixed wiring.**

**When carrying out piping connection, take care not to let air substances go into refrigeration cycle.** Otherwise, it will cause lower capacity, abnormal high pressure in the refrigeration cycle, explosion and injury.

**Do not modify the length of the power supply cord or use of extension cord, and do not share the single outlet with other electrical appliances.** Otherwise, it will cause fire or electrical shock.

**Carry out the specified installation work after taking into account strong winds, typhoons or earthquakes.** Improper installation work may result in the equipment falling and causing accidents.

If the refrigerant leaks during installation, ventilate the area immediately.

Toxic gas may be produced if the refrigerant comes into the place contacting with fire.

The temperature of refrigerant circuit will be high, please keep the interconnection cable away from the copper tube.

After completing the installation work, check that the refrigerant does not leak.

Toxic gas may be produced if the refrigerant leaks into the room and comes into contact with a source of fire, such as a fan heater, stove or cooker.



## CAUTION

### Ground the air conditioner.

Do not connect the ground wire to gas or water pipes, lightning rod or a telephone ground wire. Incomplete grounding may result in electric shocks.

### Be sure to install an earth leakage breaker.

Failure to install an earth leakage breaker may result in electric shocks.

### Connect the outdoor unit wires, then connect the indoor unit wires.

You are not allowed to connect the air conditioner with the power source until wiring and piping the air conditioner is done.

### While following the instructions in this installation manual, install drain piping in order to ensure proper drainage and insulate piping in order to prevent condensation.

Improper drain piping may result in water leakage and property damage.

### Install the indoor and outdoor units, power supply wiring and connecting wires at least 1 meter away from televisions or radios in order to prevent image interference or noise.

Depending on the radio waves, a distance of 1 meter may not be sufficient enough to eliminate the noise.

### The appliance is not intended for use by young children or infirm persons without supervision.

### Don't install the air conditioner in the following locations:

- There is petrolatum existing.
- There is salty air surrounding (near the coast).
- There is caustic gas (the sulfide, for example) existing in the air (near a hot spring).
- The Volt vibrates violently (in the factories).
- In buses or cabinets.
- In kitchen where it is full of oil gas.
- There is strong electromagnetic wave existing.
- There are inflammable materials or gas.
- There is acid or alkaline liquid evaporating.
- Other special conditions.
- The appliance shall not be installed in the laundry.

## 2. INSTALLATION INFORMATION







- To install properly, please read this "installation manual" at first.
- The air conditioner must be installed by qualified persons.
- When installing the indoor unit or its tubing, please follow this manual as strictly as possible.
- If the air conditioner is installed on a metal part of the building, it must be electrically insulated according to the relevant standards to electrical appliances.
- When all the installation work is finished, please turn on the power only after a thorough check.
- Regret for no further announcement if there is any change of this manual caused by product improvement.



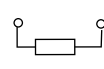

## INSTALLATION ORDER

- Select the location;
- Install the indoor unit;
- Install the outdoor unit;
- Install the connecting pipe ;
- Connect the drain pipe;
- Wiring;
- Test operation.

## 3. ATTACHED FITTINGS

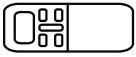
Please check whether the following fittings are of full scope. If there are some spare fittings, please restore them carefully.

Name of Accessories	Qty	Outline	Usage
Installation manual	1	(This manual)	_____
Hook	2		_____
Hanging arm	model 36~140		_____
	model 160		_____
Network matching wire	1		The indoor unit which at the terminal of communication system should connect a impedance between port P and port Q.
Drainage pipe	1		Drainage
Thermal insulation pipe (160model)	1		Keep the drainage pipe temperature
Bolt assembly	4		_____
Copper	1		Use for pipe connection of engineering installation

Remote controller & Its Frame	
1. Remote controller.....	1
	
2. Remote controller holder.....	1
	
3. Mounting screw (ST2.9x10-C-H).....	2
	
4. Alkaline dry battery(AM4) .....	2
	

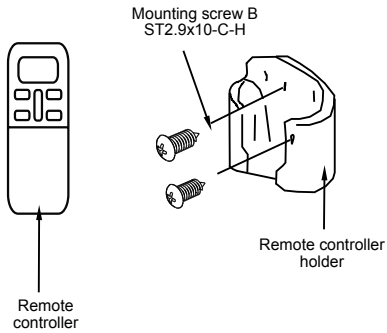

Fig.3-1



## CAUTION

- Never throw or beat the controller.
- Before installation, operate the remote controller to determine its location in a reception range.
- Keep the remote controller at least 1m apart from the nearest TV set or stereo equipment. (it is necessary to prevent image disturbances or noise interferences.)
- Do not install the remote controller in a place exposed to direct sunlight or close to a heating source, such as a stove.
- Note that the positive and negative poles are right positions when loading batteries.



## NOTE

This manual is subject to changes due to technological improvement without further notices.

## 4. INDOOR UNIT INSTALLATION

4.1 The units may be mounted vertically ,provided that the correct clearances for positioning are maintained. (Refer to Fig. 4-1 )

Version I

## WOODEN CONSTRUCTION

Put the square timber traversely over the roof beam, then install the hanging screw bolts.

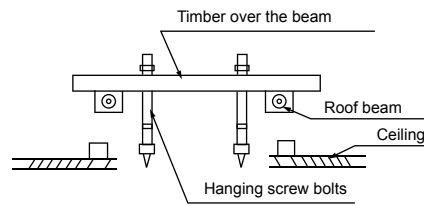

Fig.4-1

## NEW CONCRETE BRICKS

Inlaying or embedding the screw bolts.



Fig.4-2

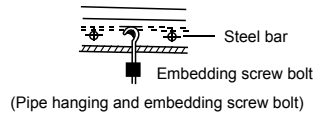

Fig.4-3

## FOR ORIGINAL CONCRETE BRICKS

Install the hanging hook with expansible bolt into the concrete deep to 45~50mm to prevent loose.

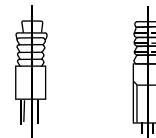

Fig.4-4

## 4.2 Wall Mounting Installation

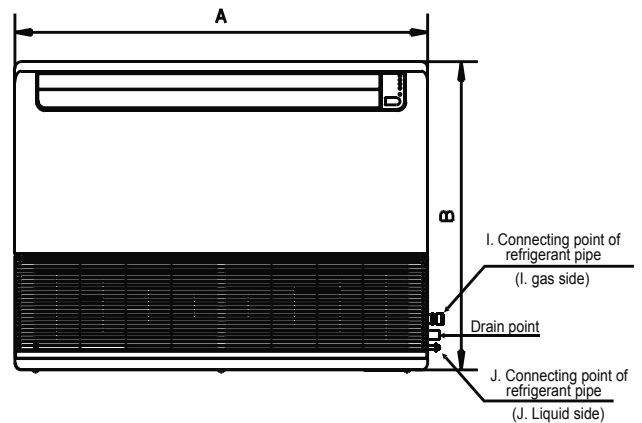

Fig. 4-5

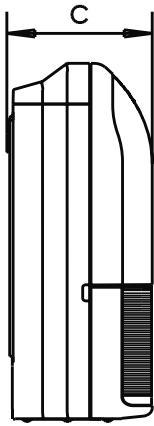

Fig. 4-6

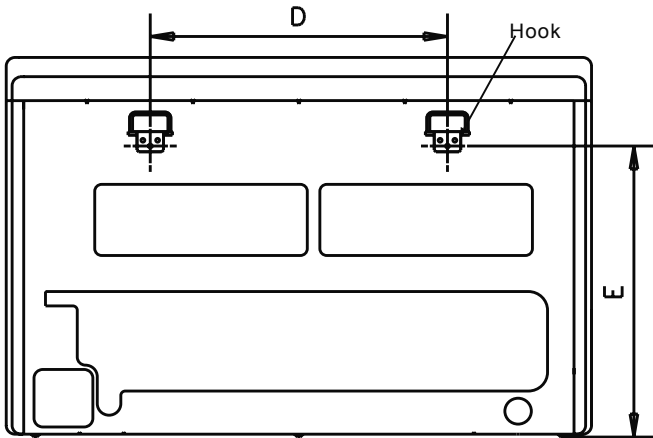

Fig. 4-7

1. Fix the hook with tapping screw onto the wall. (Refer to Fig. 4-8)

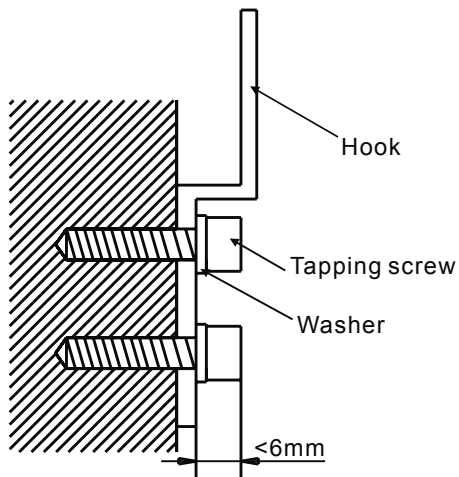

Fig. 4-8

2. Hang the indoor unit on the hook.

### 4.3 Ceiling Installation

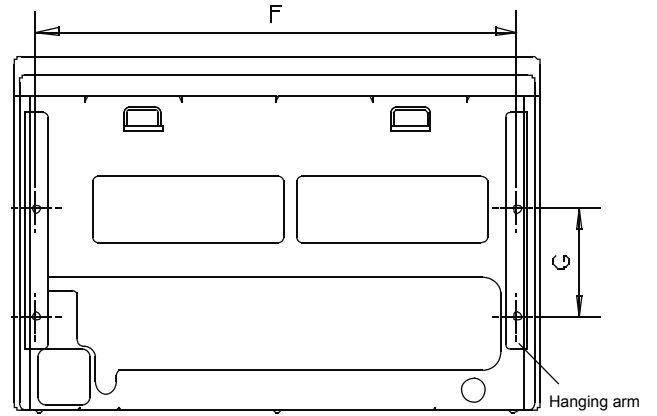

Fig. 4-9

- Remove the side board and the grille. (Refer to Fig. 4-10) (For models 48 and 60, do not remove the grille.)

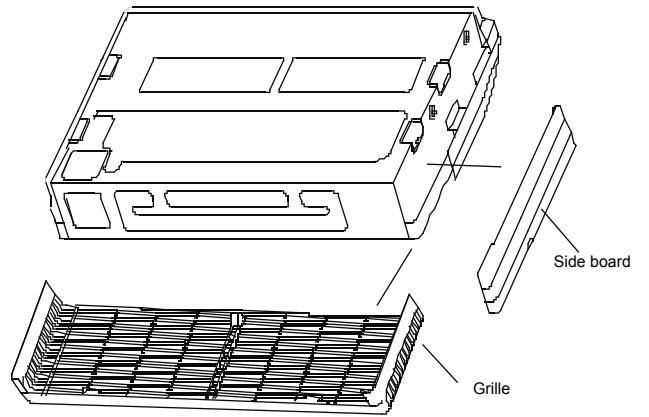

Fig. 4-10

- Locate the hanging arm on the hanging screw bolt. (Refer to Fig. 4-11) Prepare the mounting bolts on the unit. (Refer to Fig. 4-12)

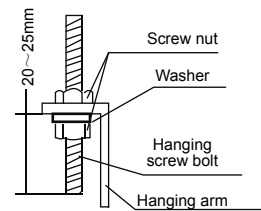

Fig. 4-11

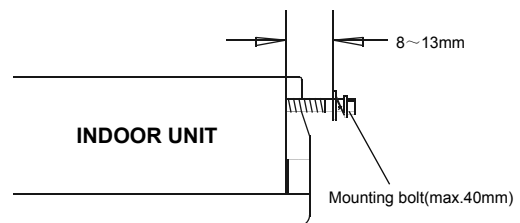
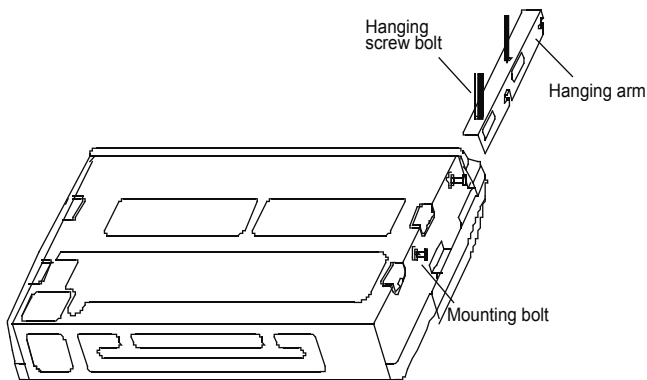

Fig. 4-12

- Hang the unit on the hanging arm by sliding backward. Securely tighten the mounting bolts on both sides. (Refer to Fig. 4-13)

3. Hang the unit on the hanging arm by sliding backward. Securely tighten the mounting bolts on both sides.



(model 36 ~ 140)

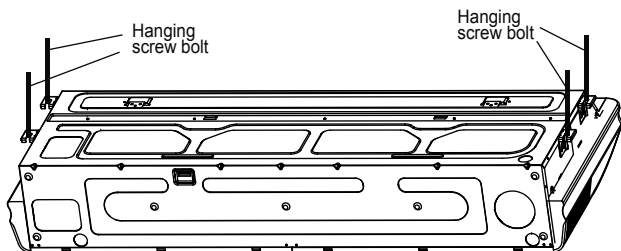

(model 160)

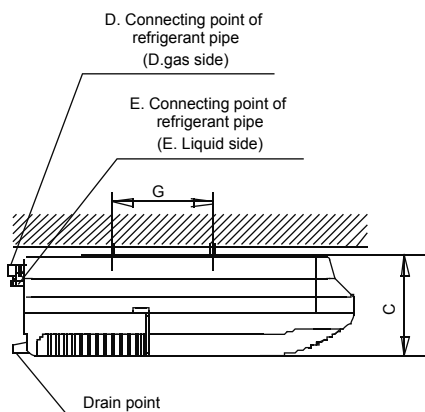
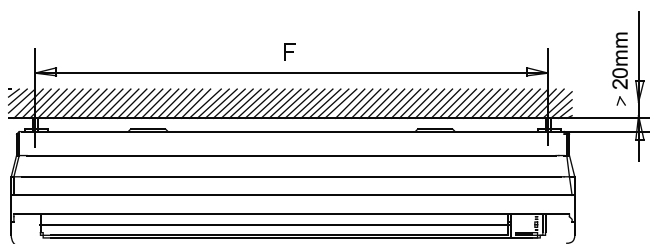

Fig. 4-13



### CAUTION

The figures above are based on model 18 as rated capacity, which may differ from the unit you purchased.

## 4.4 The dimension of the unit (Unit: mm)

Table 4-1

MODEL	A	B	C	D	E	F	G
36~71	990	660	203	505	506	907	200
80~90	1280	660	203	795	506	1195	200
112~140	1670	680	244	1070	450	1542	200
160	1670	680	285	1070	380	1613	220

## 4.5 Material and size of the piping

Table 4-2

Pipe Material		Copper Pipe for Air Conditioner		
Mode(R22/R407C)		36~45	56~90	100~140
Size(mm)	I(Liquid side)	Φ6.4	Φ9.5	Φ9.5
	J(Gas side)	Φ12.7	Φ15.9	Φ19.1

Table 4-3

Pipe Material		Copper Pipe for Air Conditioner	
Mode(R410A)		36~45	56~160
Size(mm)	I(Liquid side)	Φ6.4	Φ9.5
	J(Gas side)	Φ12.7	Φ15.9

## 5. INSTALL THE CONNECTING PIPE



### CAUTION

Do not let air, dust, or other impurities fall in the pipe system during the time of installation.  
The connecting pipe should not be installed until the indoor and outdoor units have been fixed already.  
Keep the connecting pipe dry, and do not let moisture in during installation.  
The temperature of refrigerant circuit will be high, please keep the interconnection cable away from the copper tube.

### 5.1 The Procedure of Connecting Pipes

5.1.1 Measure the necessary length of the connecting pipe, and make it by the following way.

- 1) Connect the indoor unit at first, then the outdoor unit.
  - a. Bend the tubing in proper way. Don't harm them.



### CAUTION

1. Daub the surfaces of the flare pipe and the joint nuts with frozen oil, and wrench it for 3~4 rounds with hands before fasten the flare nuts.
2. Be sure to use two wrenches simultaneously when you connect or disconnect the pipes.

2) The stop valve of the outdoor unit should be closed absolutely (as original state). Every time you connect it, first loosen the nuts at the part of stop valve, then connect the flare pipe immediately (in 5 minutes). If the nuts have been loosened for a long time, dusts and other impurities may enter the pipe system and may cause malfunction later. So please expel the air out of the pipe with refrigerant before connection.

3) Expel the air (refer to the "Expel The Air") after connecting the refrigerant pipe with the indoor unit and the outdoor unit. Then fasten the nuts at the repair-points.

#### ■ Notices For Benable pipe.

- The bending angle should not exceed 90°.
- Bending position is preferably in the bendable pipe. The larger the better it is.
- Do not bend the pipe more than three times.

■ **Bend the connecting pipe of small wall thickness.**

- Cut out a desired concave at the bending part of the insulating pipe.
- Then expose the pipe(cover it with tapes after bending).
- To prevent collapsing of deforming, please bend the pipe at its biggest radius.
- Use bender to get a small radius pipes.

■ **Use the market brass pipe.**

Be sure to use the same insulating materials when you buy the brass pipe. (More than 9mm thick)

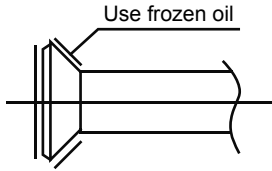

Fig. 5-1

Bend the pipe with thumb



Min-radius 100mm

Fig. 5-2

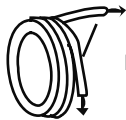

Make the ends straight

Fig. 5-3

**2. Locate The Pipe**

- 1) Drill a hole in the wall (suitable just for the size of the wall conduit, 90mm in general), then set on the fittings such as the wall conduit and its cover.
- 2) Bind the connecting pipe and the cables together tightly with binding tapes. Do not let air in, which will cause water leakage by condensation.
- 3) Pass the bound connecting pipe through the wall conduit from outside. Be careful of the pipe allocation to do no damage to the tubing.
3. Connect the pipes.
4. Then, open the stem of stop valves of the outdoor unit to make the refrigerant pipe connecting the indoor unit with the outdoor unit fluently flow.
5. Be sure of no leakage by checking it with leak detector or soap water.
6. Cover the joint of the connecting pipe to the indoor unit with the soundproof/insulating sheath (fittings), and bind it well with the tapes to prevent leakage.

## 6. CONNECT THE DRAIN PIPE

### 6.1 Install the drainpipe of the indoor unit

The outlet has PTI screw bread, Please use sealing materials and pipe sheath(fitting) when connecting PVC pipes.



#### CAUTION

- The drain pipe of indoor unit must be heat insulated, or it will condense dew, as well as the connections of the indoor unit.
- Hard PVC binder must be used for pipe connection, and make sure there is no leakage.
- With the connection part to the indoor unit, please be noted not to impose pressure on the side of indoor unit pipes.
- When the declivity of the drain pipe downwards is over 1/100, there should not be any winding.
- The total length of the drain pipe when pulled out transversely shall not exceed 20m, when the pipe is over long, a prop stand must be installed to prevent winding.
- Refer to the Fig.8-1 for the installation of the pipes.

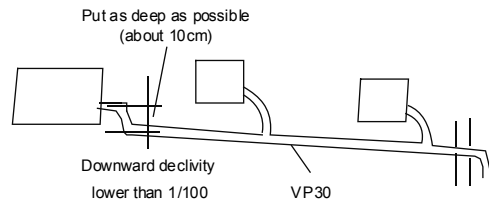
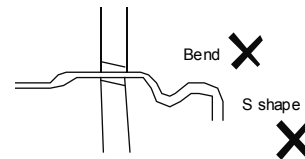
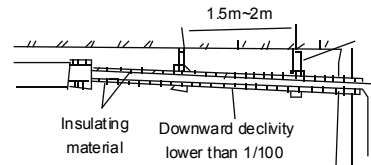

Fig. 6-1

### 6.2 Drainage test

- **Check whether the drainpipe is unhindered.**
- **New built house should have this test done before paving the ceiling.**

## 7. WIRING

- **Specified power cables should be used. Do not apply any pressure on the terminals used to connect.**  
Improper connection may cause fire.
- **Grounding must be properly done.**  
The grounding wire should be away from gas pipes, water pipes, telephone, lightning rods or other grounding wires. Improper grounding may cause electric shock.
- **Electric Wiring must be done by professionals. Use a separate circuit according to national regulations.**  
If the wiring capacity is not enough, electric shock or fire may occur.



### CAUTION

1. Be sure to Install Current Leakage Protection Switch, Or electric shock may occur.
2. Power cord is to be selected according to national regulations.
3. an all-pole disconnection device which has at least 3mm separation distance in all pole and a residual current device(RCD)with the rating of above 10mA shall be incorporated in the fixed wiring according to the national rule.
4. Outdoor unit power cord should be selected and connected according to the outdoor unit installation manual.
5. Wiring should be away from high temperature components, or the insulation layer of the wires may melt down.
6. Use wire clamp to fix the wires and terminal block after connection.
7. Control wire should be wrapped together with heat insulated refrigerant pipes.
8. Connect the indoor unit to power only after the refrigerant has been vacuumed.
9. Don't connect the power wire to the signal wire connection end.

### 7.1 The specification of power

Table 7-1

TYPE (W)		2200-14000W	16000W
Power	Phase	1-PHASE	
	Frequency & volt	220-240V~ 50Hz 208-230V~ 60Hz	
Circuit breaker/fuse (a)		5/3	5/5
Indoor unit power wiring(mm <sup>2</sup> )		1.0	
Indoor/outdoor connecting wire (mm <sup>2</sup> )	Ground wiring(mm <sup>2</sup> )	1.0	
	Weak electric signal	0.75	



### CAUTION

A disconnection device having an air gap contact separation in all active conductors should be incorporated in the fixed wiring according to the National Wiring Regulation.

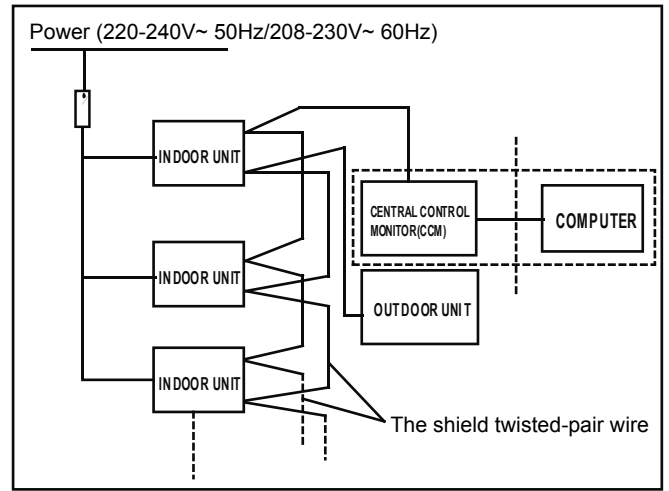

Fig. 7-1



### CAUTION

The reserved function is indicated in broken line table, users can select it when necessary

### 7.2 Indoor/outdoor unit signal wire

- Connect the wire according to their numbers.
- Wrong connection may cause malfunction .

### 7.3 Wiring connection

- Seal the wiring connection with the insulation material , or the condensing dew will be caused.

### 7.4 Panel Wiring

Connect the Swing Motor terminal block according to the Panel Installation Manual.

### 7.5 Terminal Board Diagram

Please refer to the indoor unit wiring diagram for the wiring.  
Note: The air-conditioners can connect with Central Control Monitor (CCM). Before operation, please wiring correctly and set system address and network address of indoor units.

Signal-phase power supply model

Fig. 7-2

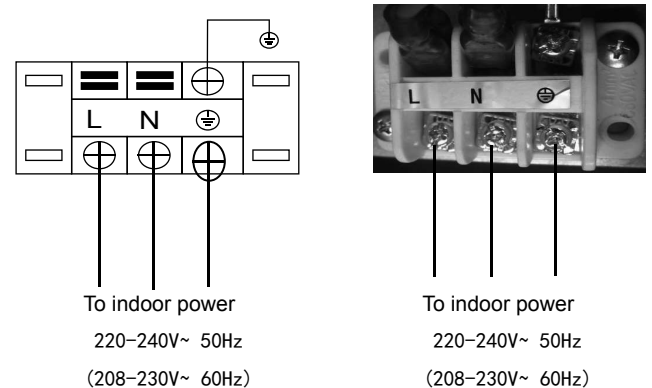



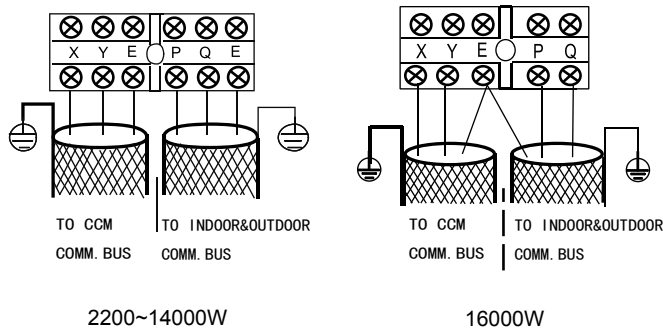

Please adopt the shielded twisted-pair wire, and connect the shielded layer to (E) Fig. 7-3

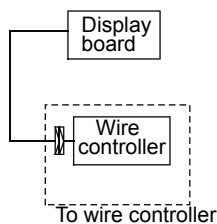

The reserved wire control function is indicated in broken table, user can purchase the wire controller when necessary. Fig. 7-4

## 8. CONTROL OPERATION

### 8.1 Horsepower set

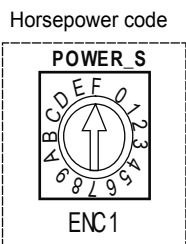

Base on different purposes to setting the switch cords on PC panel of indoor electrical control box. Once finish the setting, please cut off the main power, and then input power again, otherwise, setting function could not work.

Table: 8-1

ENC1	Switch	For setting the cooling output
Note: No one are permitted to alter the cooling output which be set before shipping from factory, except licensed maintain personnel.	Switch cord	Setting the cooling output
	1	2800 W
	2	3600 W
	3	4500 W
	4	5600 W
	5	7100 W
	6	8000 W
	7	9000 W
	8	10000 W
		11200 W
9	14000 W	
A	16000 W	



### CAUTION

The system together have 64units(0-63),everyone has only system addresscode,If two addresses are the same in one system , the abnormal operation will occur.

Please switch off the power before setting,otherwise the unexpected error will occur.

### 8.2 Network address set

1) Network address is set by communication of indoor and outdoor unit; the address is the same as indoor address, there is no need to set separately.

2) The central control of indoor units can be done on outdoor unit, there is no need to control indoor unit separately, for details please refer to V4+ outdoor unit manual.

3) For previous control of indoor units, the network can be set by connecting (X,Y,E) terminals, there is no need to set network address. The network can also be set by outer network module and main board (CN20).



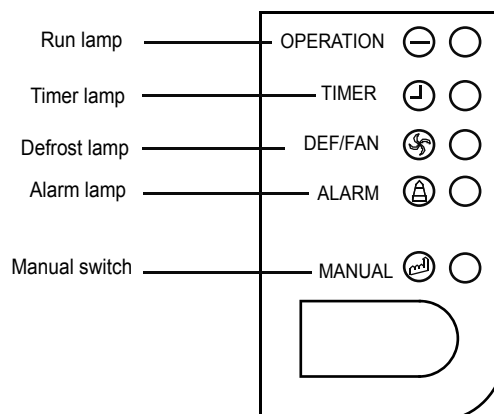



### 8.3 TROUBLE SHOOTING











No.	Type	Contents	LED lamp flash	Remarks
1	Malfunction	The evaporator sensor check point is abnormal or room temp. sensor is abnormal.	Run lamp flashes quickly.	After the malfunctions disappear, it restores automatically.
2	Malfunction	Indoor/outdoor unit communication is abnormal.	The timer lamp flashes quickly	After the malfunctions disappear, it restores automatically.
3	Malfunction	Condenser sensor check point is abnormal or outdoor temp. sensor is abnormal.	All the indoor alarm lamps flash slowly.	After the malfunctions disappear, it restores automatically.
4	Malfunction	Water level switch is abnormal	Alarm lamp flashes quickly	If the malfunctions can't be solved in three minute all the indoor alarm lamps flash at 0.5Hz. Turn off the power to restore.

## 8.4 Main board Code designation





### SW1 definition

ON 	<ul style="list-style-type: none"> <li>● 1 means factory test mode</li> <li>● 0 means add. auto searching mode (default setting)</li> </ul>	ON 	<ul style="list-style-type: none"> <li>● 01 means DC fan static pressure is 1 (reserved)</li> </ul>
ON 	<ul style="list-style-type: none"> <li>● 1 means DC fan is chosen</li> <li>● 0 means AC fan is chosen</li> </ul>	ON 	<ul style="list-style-type: none"> <li>● 10 means DC fan static pressure is 2 (reserved)</li> </ul>
ON 	<ul style="list-style-type: none"> <li>● 00 means DC fan static pressure is 0 (reserved)</li> </ul>	ON 	<ul style="list-style-type: none"> <li>● 11 means DC fan static pressure is 3 (reserved)</li> </ul>



### SW2 definition

ON 	<ul style="list-style-type: none"> <li>● 00 means the temperature is 15 degrees when shutting down the unit for cold wind proof.</li> </ul>	ON 	<ul style="list-style-type: none"> <li>● 00 means the time of stopping TERMAL fan is 4 minutes</li> </ul>
ON 	<ul style="list-style-type: none"> <li>● 01 means the temperature is 20 degrees when shutting down the unit for cold wind proof.</li> </ul>	ON 	<ul style="list-style-type: none"> <li>● 01 means the time of stopping TERMAL fan is 8 minutes</li> </ul>
ON 	<ul style="list-style-type: none"> <li>● 10 means the temperature is 24 degrees when shutting down the unit for cold wind proof.</li> </ul>	ON 	<ul style="list-style-type: none"> <li>● 10 means the time of stopping TERMAL fan is 12 minutes</li> </ul>
ON 	<ul style="list-style-type: none"> <li>● 11 means the temperature is 26 degrees when shutting down the unit for cold wind proof.</li> </ul>	ON 	<ul style="list-style-type: none"> <li>● 11 means the time of stopping TERMAL fan is 16 minutes</li> </ul>



SW5 definition

ON 	● 00 means temperature compensation is 6 degrees under heating mode	ON 	● 10 means temperature compensation is 4 degrees under heating mode
ON 	● 01 means temperature compensation is 2 degrees under heating mode	ON 	● 11 means temperature compensation is 8 degrees under heating mode

SW6 definition

ON 	● 1 means old display panel ● 0 means new display panel
ON 	● 1 means auto wind under auto mode ● 0 means auto wind under non auto mode
ON 	reserved



J1, J2 definition

J1 	J1 no Jumpers means power off memory function
J1 	J1 Jumpers means no power off memory function
J2 	reserved

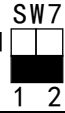
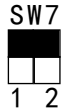
SW7 definition

ON 	Standard configure
ON 	Last one in the network

0/1 definition

ON 	Means 0
ON 	Means 1

## 9. TEST OPERATION

- 1 The test operation must be carried out after the entire installation has been completed.
- 2 Please confirm the following points before the test operation:
  - The indoor unit and outdoor unit are installed properly.
  - Tubing and wiring are correctly completed.
  - The refrigerant pipe system is leakage-checked.
  - The drainage is unimpeded.
  - The heating insulation works well.
  - The ground wiring is connected correctly.
  - The length of the tubing and the added stow capacity of the refrigerant have been recorded.
  - The power voltage fits the rated voltage of the air conditioner.
  - There is no obstacle at the outlet and inlet of the outdoor and indoor units.
  - The gas-side and liquid-side stop valves are both opened.
  - The air conditioner is pre-heated by turning on the power.
- 3 According to the user's requirement, install the remote controller frame where the remote controller's signal can reach the indoor unit smoothly.
- 4 Test operation
  - Set the air conditioner under the mode of "COOLING" with the remote controller, and check the following points. If there is any malfunction, please resolve it according to the chapter "Troubleshooting" in the "Owner's Manual".
    - 1) The indoor unit
      - a. Whether the switch on the remote controller works well.
      - b. Whether the buttons on the remote controller works well.
      - c. Whether the air flow louver moves normally.
      - d. Whether the room temperature is adjusted well.
      - e. Whether the indicator lights normally.
      - f. Whether the temporary buttons works well.
      - g. Whether the drainage is normal.
      - h. Whether there is vibration or abnormal noise during operation.
      - i. Whether the air conditioner heats well in the case of the HEATING/COOLING type.
    - 2) The outdoor unit
      - a. Whether there is vibration or abnormal noise during operation.
      - b. Whether the generated wind, noise, or condensed of by the air conditioner have influenced your neighborhood.
      - c. Whether any of the refrigerant is leaked.



### CAUTION

A protection feature prevents the air conditioner from being activated for approximately 3 minutes when it is restarted immediately after shut off.

---

MDV10I-016GW

202000171519