

Application guide

Your tool for designing efficient balancing solutions for heating and cooling systems

18
applications

Our recommended
applications for heating
and cooling systems
will improve comfort and
make you pay even less.

Structure

1.1	Recommended solution for heating systems	4
1.2	Recommended solution for cooling systems	6
2.1.1	Variable flow system, typical application in FCU heating-cooling systems and any kind of terminal unit (e.g. AHU)	8
2.1.2	Variable flow system, typical application in FCU heating (cooling) systems and from time to time in AHU	10
2.1.3	Constant flow system, typical application in FCU heating-cooling systems and in AHU	12
2.1.4	Constant flow system, typical application in FCU heating-cooling systems and in AHU	14
2.1.5	Variable flow system, typical application in surface (beam) heating-cooling systems, where we use the same equipment for heating and cooling	16
2.1.6	Variable flow two pipe heating/cooling system, typical application in FCU systems and any kind of terminal units (e.g. chilled beam)	18
2.1.7	Constant flow solar systems, typical application for collectors – mainly for domestic hot preparation and preheating of heating water	20
2.1.8	Chiller application – primary variable flow ⁰⁾ system with headered pumps and controlled minimum required flow through the chiller plant	22
2.1.9	Variable flow system, typical application in FCU, surface and other type of combined heating/cooling systems with self acting room temperature controller	24
2.1.10	Variable flow system, typical application in two pipe heating system riser control without thermostatic radiator valve	26
2.1.11	One pipe radiator heating systems with thermostatic radiator valves and automatic return temperature limiter	28
2.1.12	One pipe horizontal heating systems with thermostatic radiator valves and automatic return temperature limiter	30
2.1.13	Variable flow system, typical application in two pipe surface (floor or wall) heating systems with manifolds and individual room controller	32
2.1.14	Two pipe horizontal heating systems with individual flat connection, including thermostatic radiator valves, automatic pressure difference controller and zone control	34
2.1.15	Variable flow system, typical application in flat station business	36

2.1.16	Variable flow system, typical application in ventilation heating units, air curtains etc.	38
2.1.17	Variable flow system with automatic temperature balancing in Domestic Hot Water circulation network	40
2.1.18	Variable flow system with automatic temperature balancing in Domestic Hot Water circulation network	42
2.2.1	Variable flow system, often used in radiator heating, FCU heating/cooling systems and in AHU	44
2.2.2	Variable flow system, often used in radiator heating, FCU heating/cooling systems and in AHU – version with flow limiters and MCV	46
2.2.3	Variable flow two pipe heating/cooling system, typical application in FCU systems and any kind of terminal units (e.g. surface heating/cooling)	48
2.2.4	Constant flow system with manual balancing in Domestic Hot Water circulation network	50
2.3.1	Variable flow system, application in two pipe radiator heating systems with thermostatic radiator valve and flow limiter	52
3	Signs and abbreviations of 2.1, 2.2 and 2.3	54
3.0	Valve authority	56
3.1	The “low ΔT syndrome”	60
3.2	The “overflow phenomenon”	61
3.3	The “underflow phenomenon”	64
4	Project case study: comparison of 2.1.1, 2.1.2 and 2.1.4 applications	65
4.1	Operational costs	65
4.1.1	Pumping energy saving	66
4.2	Investment cost comparison	70
4.3	Hydronic analyzer case study (Sunway Lagoon Hotel)	72
5	Product overview	75
5.1	ABPCV – Automatic Balancing Pressure Control Valves	75
5.2	PIBCV: Pressure Independent Balancing & Control Valves	75
5.3	MBV: Manual Balancing Valves	77
5.4	MCV: Zone Valve, Motorised Control Valves	78
5.5	SARC: Self Acting Room Controllers	80
5.6	RC : Room Controllers	80
5.7	DHWC: Domestic Hot Water Controllers	81



1.1

Recommended solution for heating systems

HEATING SYSTEM

ONE PIPE system

Systems with or without TRV'S

RECOMMENDED ADJUSTABLE FLOW LIMITER:
AB-QM, QT, CCR3



Systems with or without TRV'S

ACCEPTABLE
LENO MSV-BD,
LENO MSV-B/S/O



TWO PIPE system

Systems with TRV'S

Without presetting

RECOMMENDED
ASV-P/PV + ASV-BD
AB-PM



With presetting

RECOMMENDED
ASV-P/PV + ASV-BD
AB-PM



RECOMMENDED
ASV-PV + MSV-F2 (with impulse tube)



Sanitary water system

Systems without TRV'S

Upgrade to TRV'S not possible

RECOMMENDED
LENO MSV-B/S/O
LENO MSV-BD
/USV-I



Upgrade to TRV'S is possible

RECOMMENDED
USV-M + USV-I
(upgradable)



Domestic hot water circulation system

RECOMMENDED
MTCV, CCR2





1.2

Recommended solution for cooling systems

COOLING SYSTEM

CONSTANT FLOW

Automatic balancing

Manual balancing

RECOMMENDED
ADJUSTABLE FLOW
LIMITER:
AB-QM



ACCEPTABLE
MSV-F2, LENO MSV-BD
LENO MSV-B/O/S



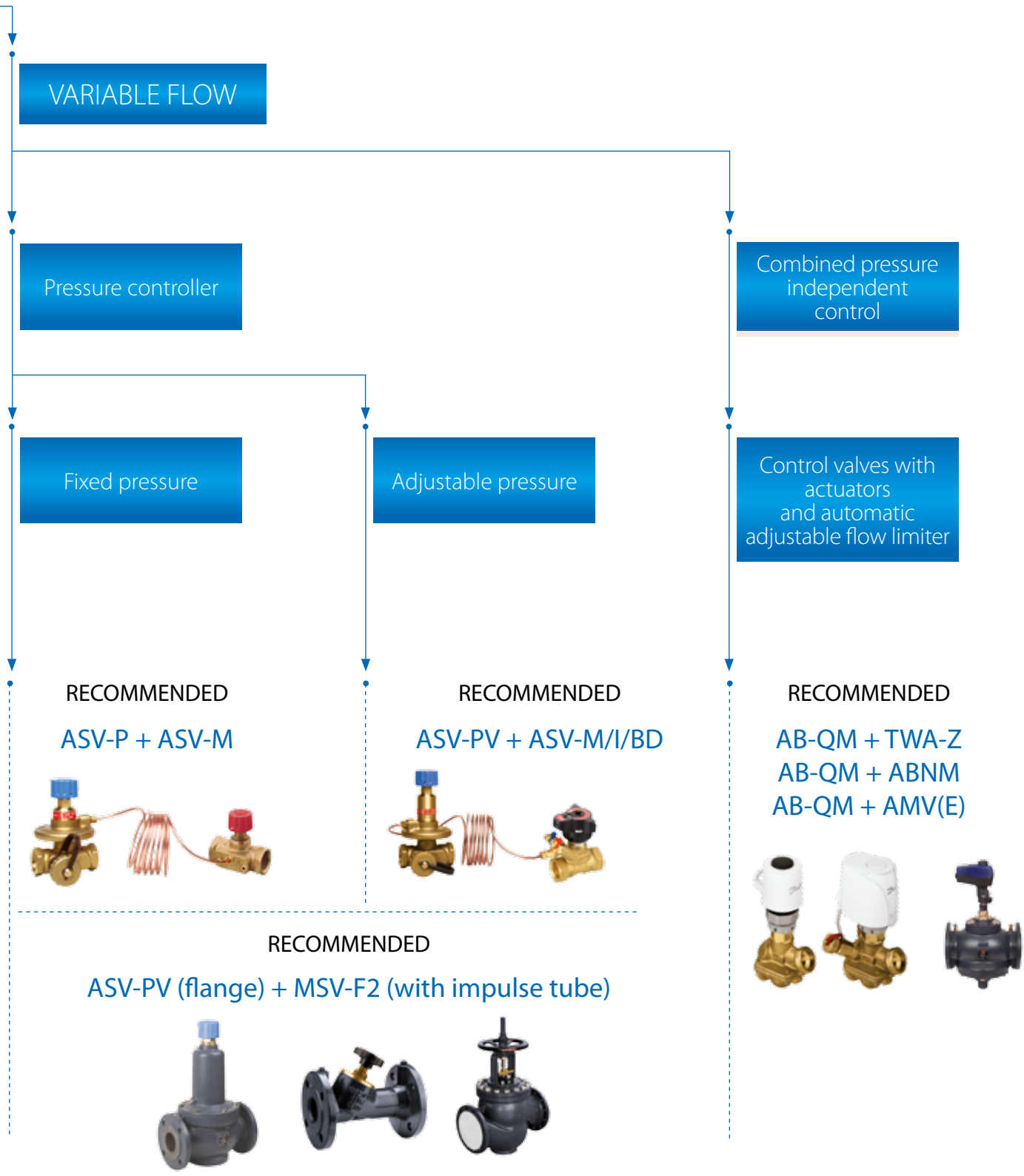



2.1.1

Variable flow system, typical application in FCU heating-cooling systems and any kind of terminal unit (e.g. AHU)

(In this application variable flow in the distribution pipeline and flow limitation (or control) in the entire terminal unit independently from the pressure oscillation in the system. With this we eliminate any kind of overflow during the whole operation period.)

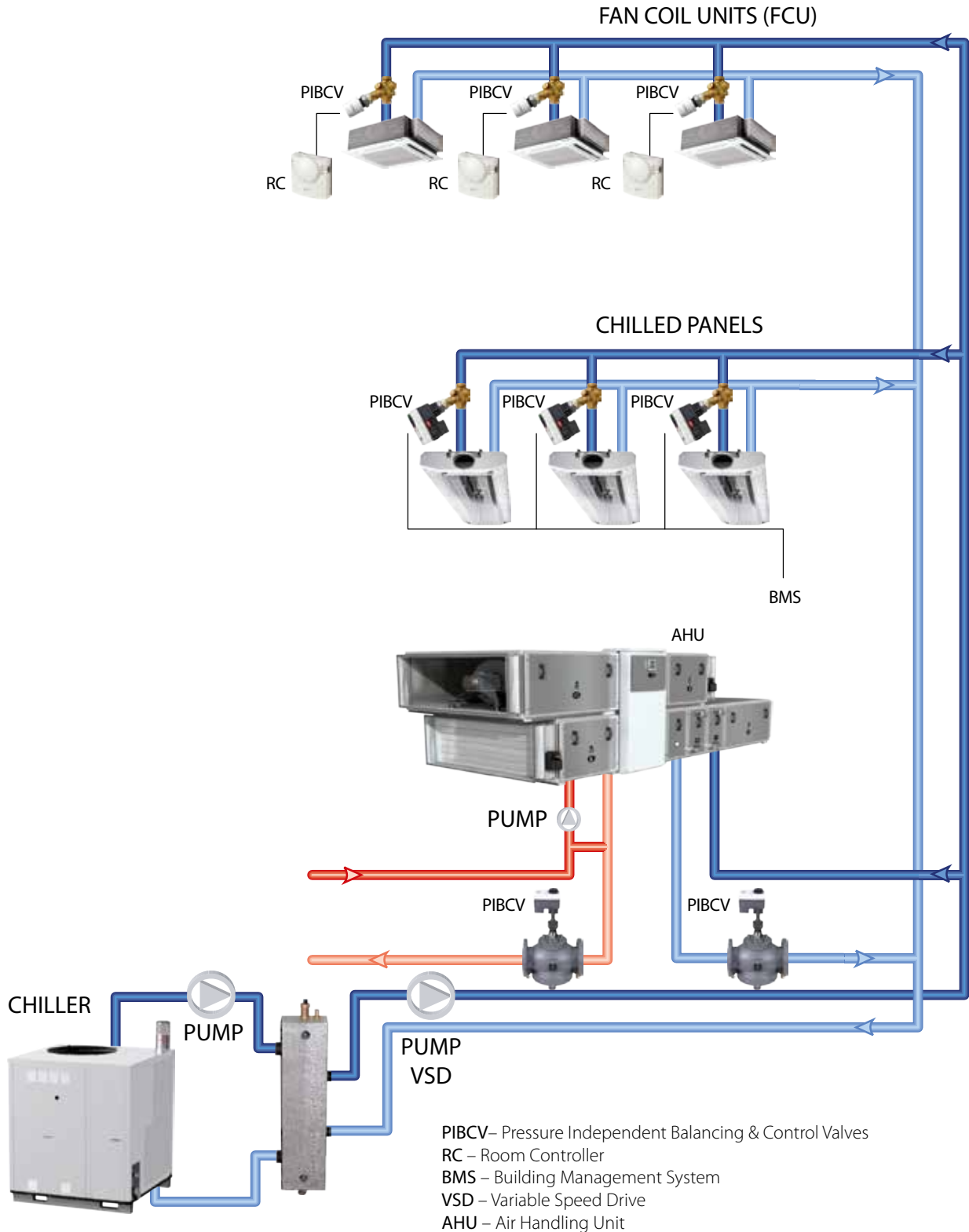

*Recommended – correct engineering, high efficiency

1

Design / Sizing

- **SIMPLE CALCULATION METHOD**: no Kvs, authority or hydraulic presetting calculation
- Authority 100% – pressure independent control
- Simplified flow setting calculation according to heat demand
- Pump head calculation according to min. Δp on the valve and system pressure loss at nominal flow

2

Operational cost

- **LOWEST** pumping costs ^{F)} (no overflow phenomenon)
- Heat losses and heat gains on the pipeline are minimal
- **LOWEST** pump head demand
- Optimization of pump ^{J)} head is recommended
- Control valves – **100% AUTHORITY** and best efficiency – minimum room temperature oscillation ^{K)}
- Re-commissioning ^{L)} of the system is not required

3

Investment

- Investment cost ^{M)} – **GOOD** (only 2 port PIBCV)
- No hydraulic element in the system anymore
- The least number of valves in the system (less installation ^{N)} cost)
- Commissioning ^{O)} of the system not required
- Variable speed drive ^{P)} is recommended (proportional characteristic)

4

Designed ready for installation

- Hydraulic regulation only in terminal units with **100% AUTHORITY**
- Balancing at full and partial load – **EXCELLENT**
- Commissioning not required at all
- Variable speed pump ensures highest energy saving ^{Q)}

5

Other

- PIBCV is able to close against 6 bar
- **ZERO OVERFLOW** ^{R)}
- Usual pump optimized
- Minimal total energy consumption
- **MAXIMUM ENERGY SAVING**



2.1.2

Variable flow system, typical application in FCU heating (cooling) systems and from time to time in AHU

(In this application variable flow in the distribution pipeline and constant differential pressure on either branches or AHUs independently from the pressure oscillation in the system. With this we reduce most of the unnecessary overflow and noise problem in part load operation.)

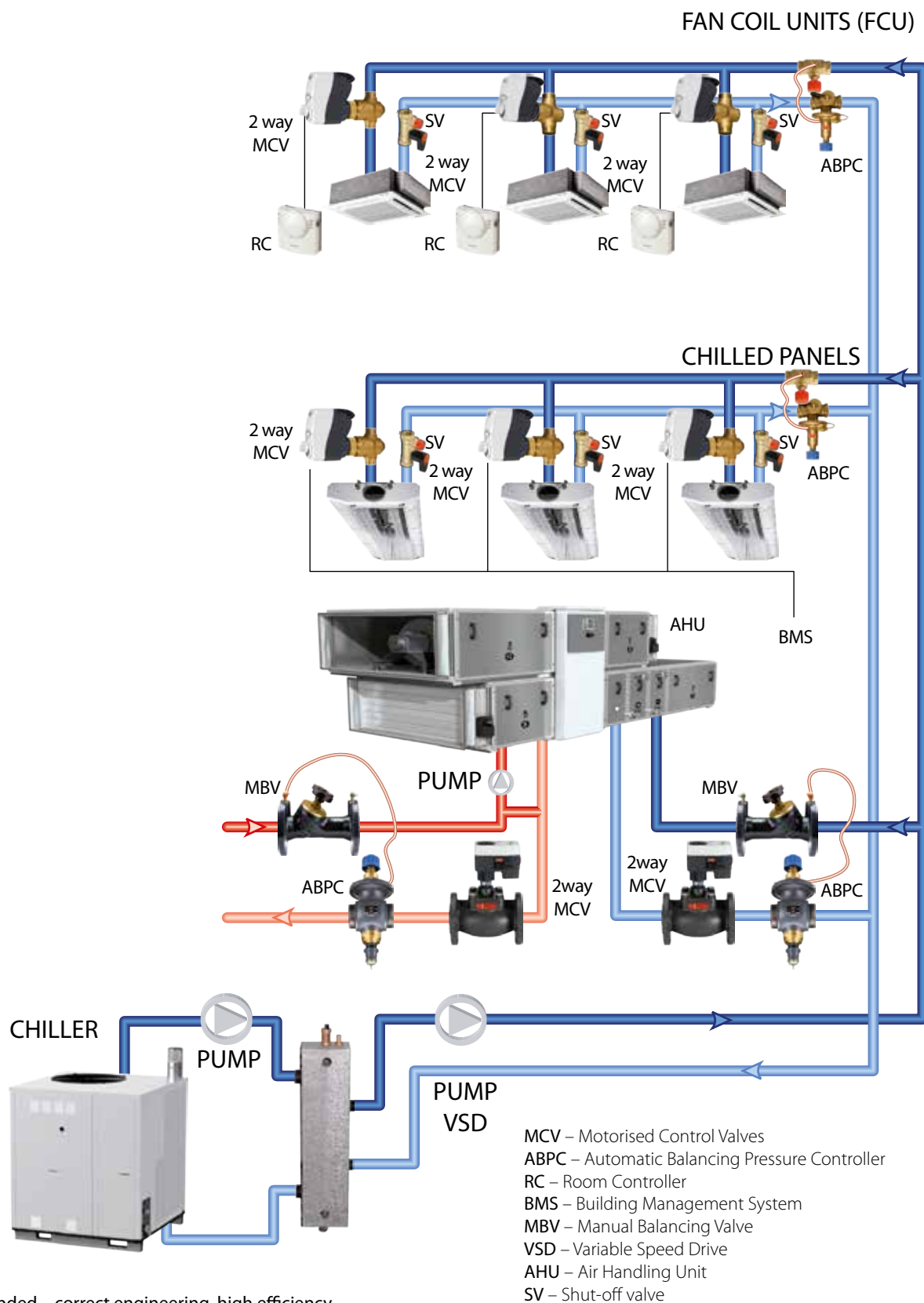

*Recommended – correct engineering, high efficiency

1

Design / Sizing

- **TRADITIONAL CALCULATION^{A)} REQUIRED:**
- Kvs of the valve, authority on the MCV
- According to the implied hydraulic calculation (you can split the system according to the controlled loop)
- Presetting calculation within the controlled loop is needed
- Pump head calculation according to nominal flow

2

Operational cost

- **LOW** pumping costs^{F)} (limited length due to risk of overflow phenomenon)
- Heat losses and heat gains on the pipeline are small
- Higher pump head demand – extra pressure loss on Δp controller required
- Optimization of the pump head^{J)} is practical
- Control valves – possible to achieve good authority^{E)} and better efficiency – lower room temperature oscillation^{K)}
- Re-commissioning^{C)} of the system is not required (only in case of long controlled loop)

3

Investment

- Investment cost^{I)} – **HIGH** (2 port valve + ABPC by loops)
- Expensive big dimension automatic Δp controller (ABPC)
- Commissioning^{B)} of the system not required only in case of long controlled loop
- Variable speed pump^{S)} is recommended (constant pressure characteristic)
- MBV is needed in the loop of the terminal unit to ensure flow setting for long loops.

4

Designed ready for installation

- Hydraulic regulation only in terminal units the Δp on the control valve nearby is constant
- Balancing at full and partial load – **GOOD**
- Commissioning not required only in case of long controlled loop (presetting of valve needed)
- Variable speed pump ensures energy saving^{T)}

5

Other

- Closing pressure of zone valves should be 50% more than the pressure setting on the ΔP controller, to ensure right authority of the control valve.
- Slight overflow during partial load condition (manual balancing within the loop)
- Usually pump oversized and overloaded to achieve normal authority on the MCV



2.1.3

Constant flow system, typical application in FCU heating-cooling systems and in AHU
(In this application we ensure 100% constant flow in the distribution pipeline. This application applies to automatic balancing solution and avoids unnecessary overflow in the part load operation.)

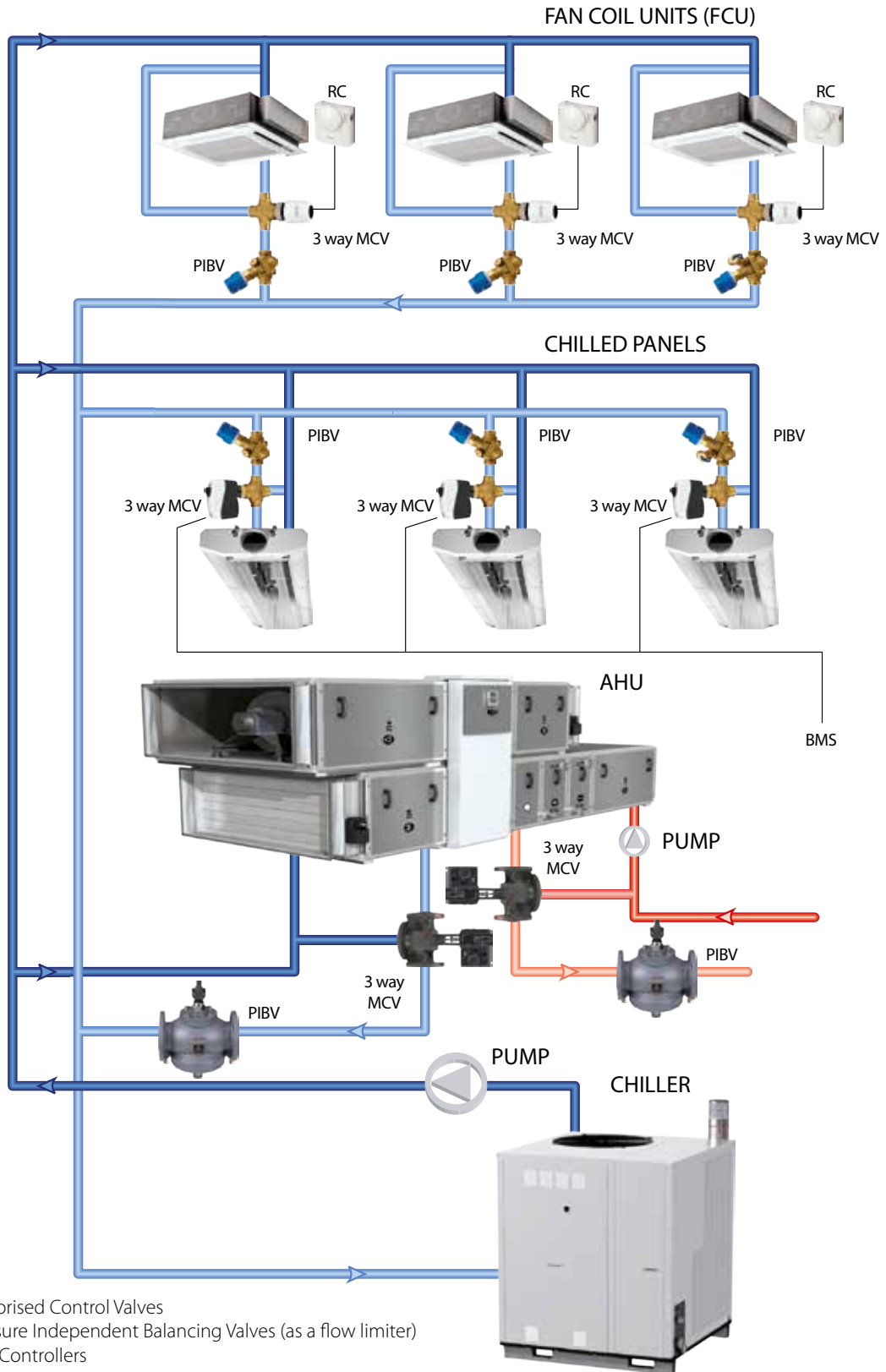

- MCV – Motorised Control Valves
- PIBV – Pressure Independent Balancing Valves (as a flow limiter)
- RC – Room Controllers
- BMS – Building Management System

*Acceptable – correct engineering, less efficient

1

Design / Sizing

- **TRADITIONAL CALCULATION^{A)} REQUIRED FOR MCV:**
- Kvs and authority of the valve
- Simplified hydraulic calculation with flow limiter (no presetting needed, only setting of the flow)
- Pump head calculation according to nominal flow

2

Operational cost

- **HIGH** pumping costs^{F)}
- Heat losses and heat gains on the pipeline are high
- Optimization of the pump^{J)} head not possible if the head pump is not on pump curve
- Control valves – acceptable authority^{E)} but low efficiency minimum room temperature oscillation^{K)} (in case of modulation control)
- **LOW ΔT PROBLEMS^{H)}** has no control on return temperature, lower boiler and cooling machine efficiency

3

Investment

- Investment cost^{I)} – **VERY HIGH** (3 port valve + PIBV)
- Hydraulic regulation only in terminal units
- Less valves than 2.1.4. application, lower installation costs
- Commissioning^{B)} of the system not required

4

Designed ready for installation

- Balancing at full and partial load – **VERY GOOD**, all the time real constant flow
- Commissioning of the system not required not even if the system is extended or changed
- Pump energy consumption constant, far higher than in variable flow^{O)} system

5

Other

- Closing pressure of zone valves should be equal with pump head at zero flow, pressure is not relieved
- Balancing at partial load – acceptable to **GOOD** depends on pump capacity
- Usually pump oversized but the flow is according to set value on flow limiter
- **REAL CONSTANT FLOW SYSTEM**



2.1.4

Constant flow system, typical application in FCU heating-cooling systems and in AHU

(In this application we ensure approximate constant flow in the distribution pipeline. This is a solution from the times when energy was cheap and automatic balancing valves were not available.)

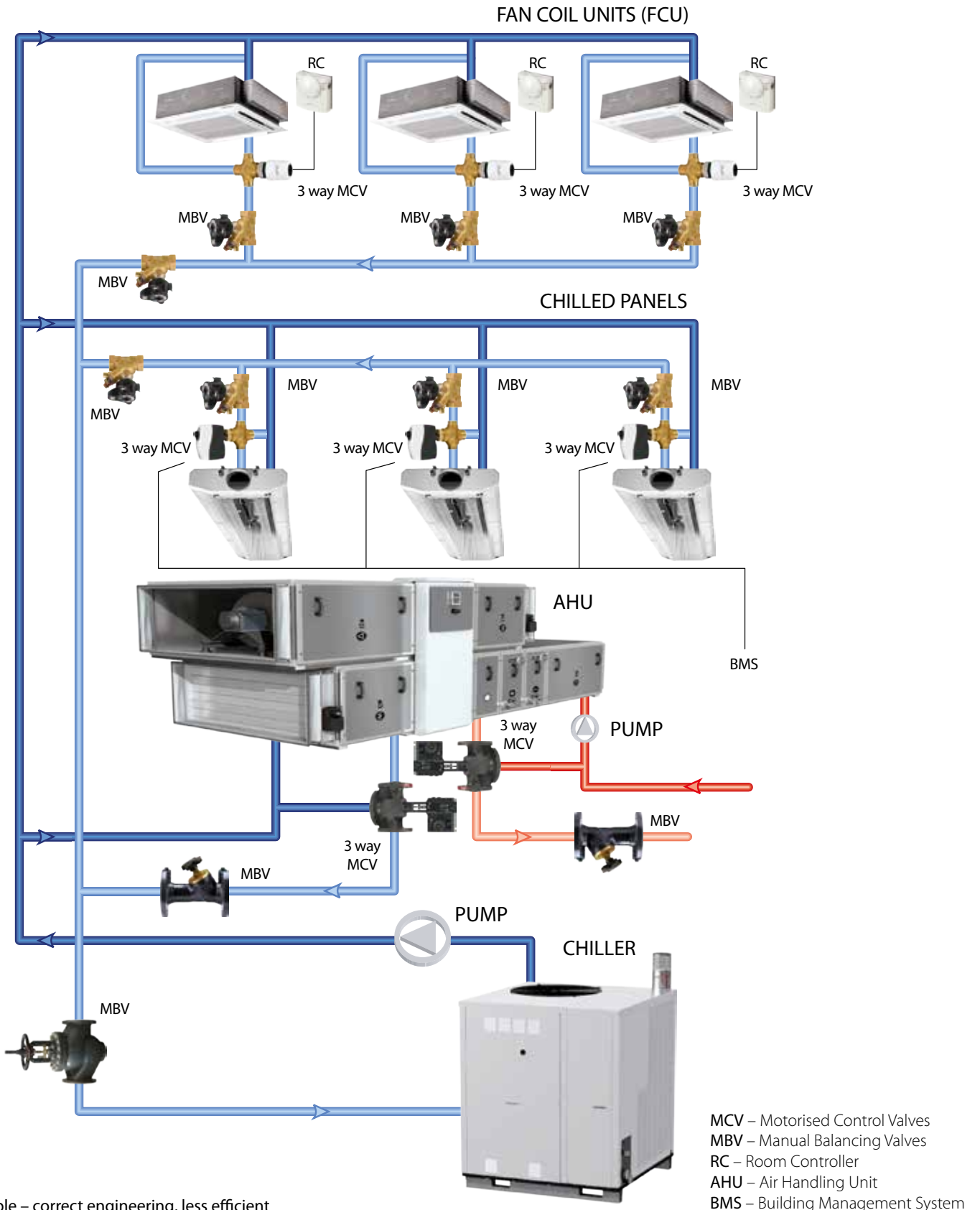

*Acceptable – correct engineering, less efficient

1

Design / Sizing

- **TRADITIONAL CALCULATION^{A)} REQUIRED:**
- Kvs of the valve, authority on MCV , presetting MBV
- Simplified hydraulic calculation with flow limiter (no presetting needed, only setting of the flow)
- Pump head calculation according part load operation (overflow on by-pass)

2

Operational cost

- **VERY HIGH** pumping costs^{F) 3,2} (due to overflow phenomenon)
- Heat losses and heat gains on the pipeline are high
- Optimization of pump head^{J)} **NOT POSSIBLE**. Only if partner valves^{N)} are implemented (MBV). Use compensation commissioning method^{D)}
- Control valves – good authority and high efficiency cannot be achieved^{E)}, higher room temperature oscillation^{K)} (in case of modulation control)
- **LOW ΔT SYNDROME^{H)}** has no control on return temperature, lower boiler and cooling machine efficiency
- From time to time re-commissioning^{C)} is needed (according EPBD^{R)} role) – from experienced commissioning team

3

Investment

- Investment cost^{I)} – **HIGH** (3 port valve + MBV + commissioning)
- High dimension of the partner valves^{N)} are required
- More valves – higher installation costs^{I)} (especially with extra flanges for the bigger valves!)
- **COMMISSIONING^{B)}** of the system required

4

Designed ready for installation

- Balancing at full and partial load – **VERY GOOD**, all the time real constant flow
- Commissioning of the system required in any case
- In partial load operation the flow will be 20-40% higher than designed flow, bigger pump is needed
- Pumping cost^{F)} are far higher in partial load operation

5

Other

- Closing pressure of zone valves should be equal with the pump head at zero flow, pressure is not relieved
- Usually the pump is oversized and overloaded to ensure the correct condition for the MBV
- **NOT REAL CONSTANT FLOW^{G)}** system if MBV is missing from by-pass^{P)} (e.g. at FCU)



2.1.5

Variable flow system, typical application in surface (beam) heating-cooling systems, where we use the same equipment for heating and cooling

(In this application we ensure variable flow in both heating and cooling distribution pipeline independently from each other. We ensure flow limitation (or control) sequentially (heating or cooling) in terminal units independently from pressure oscillation in the system. With this we eliminate any kind of overflow during the whole operation period.)

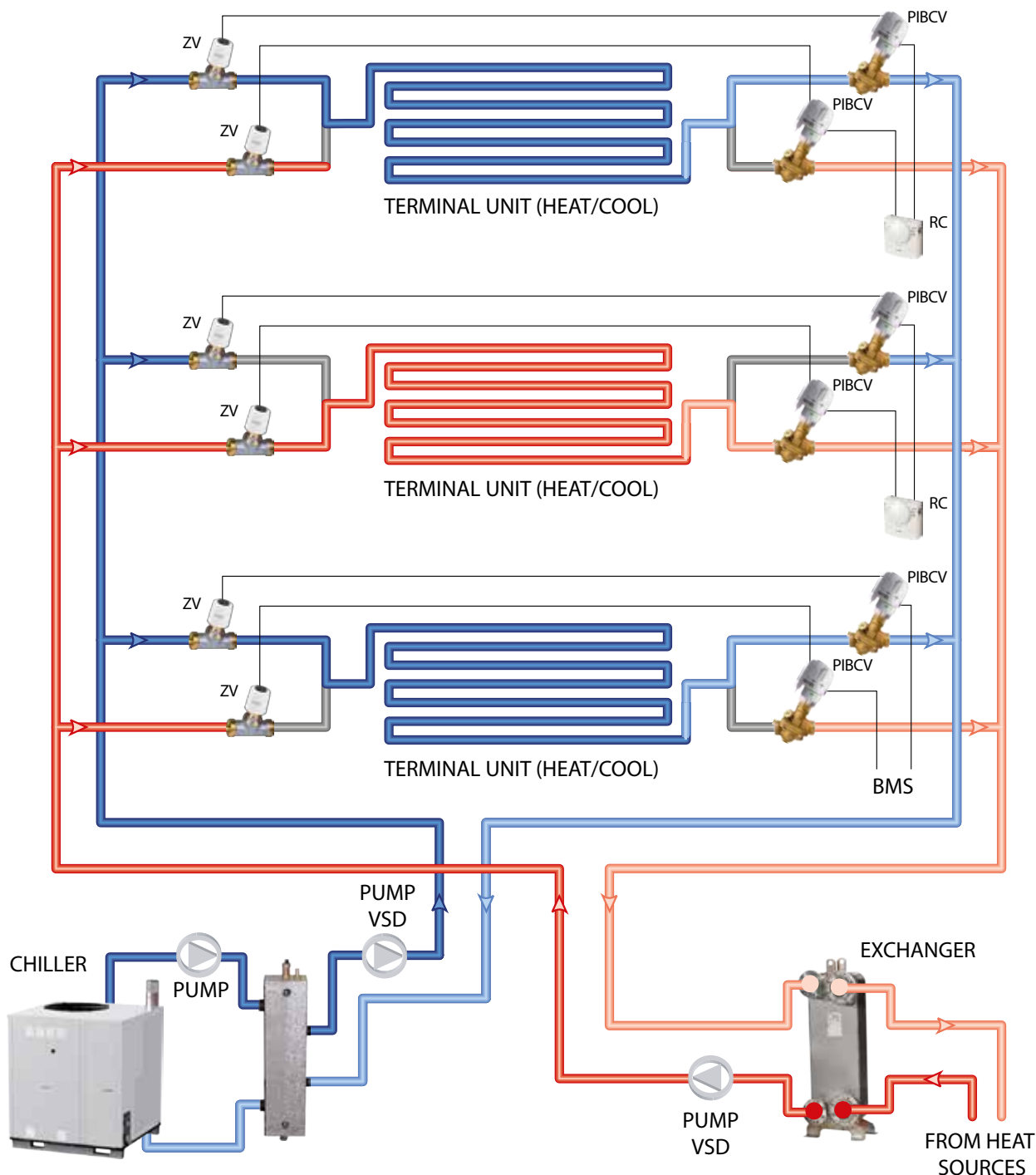

- PIBCV – Pressure Independent Balancing & Control Valves
- RC – Room Controller
- BMS – Building Management System
- VSD – Variable Speed Drive
- ZV – Zone Valves

*Recommended – correct engineering, high efficiency

1

Design / Sizing

- **SIMPLE CALCULATION METHOD**: no Kvs, authority or hydraulic presetting calculation
- **AUTHORITY 100%** – pressure independent control both in heating and cooling distribution pipeline independently from each other
- Simplified flow setting calculation according to heat demand
- Pump head calculation according to min. Δp on the valve and system pressure loss at nominal flow
- Zone valve needed for sequential control of heating and cooling

2

Operational cost

- **LOWEST** pumping costs^{F)} (no overflow phenomenon)
- Heat losses and heat gains on the pipeline are minimal
- Lowest pump head demand
- Optimization of pump head^{J)} is recommended
- Control valves – **100% AUTHORITY** and best efficiency – minimum room temperature oscillation^{K)}
- Re-commissioning^{Q)} of the system is not required

3

Investment

- Investment cost^{I)} – **MEDIUM** (2 pcs. PIBCV for balancing and 2 pcs. for zone control)
- No hydraulic element in the system more, only zone valve for sequential control
- Two times two valves for each terminal unit (medium installation^{L)} cost)
- Commissioning of the system not required^{B)}
- Variable speed pump^{S)} is recommended

4

Designed ready for installation

- Hydraulic regulation only in terminal units with 100% authority
- Balancing at full and part load – **EXCELLENT**
- Commissioning not required at all – only flow setting
- Low room temperature oscillation^{K)}
- Variable speed pump ensures highest energy saving^{T)}

5

Other

- PIBCV is able to close against 6 bar
- No overflow phenomenon^{L)}
- Usually pump optimized
- Minimal total energy consumption, **MAXIMUM ENERGY SAVING**
- Electrical connection to avoid parallel operation of heating and cooling



2.1.6

Variable flow two pipe heating/cooling system, typical application in FCU systems and any kind of terminal units (e.g. chilled beam)

(In this application it is not possible to ensure heating and cooling parallel within the building. In the heating/cooling centre we have to switch over to the zone valves according to the overall demand in the building. We ensure variable flow in the distribution pipeline and flow limitation (or control) in terminal units individually according heating or cooling flow demand with parallel connected PIBCV valves. The changeover between AB-QM' s (heating or cooling) is solved by a pipe sensor. With this we eliminate any kind of overflow during the whole operation period.)

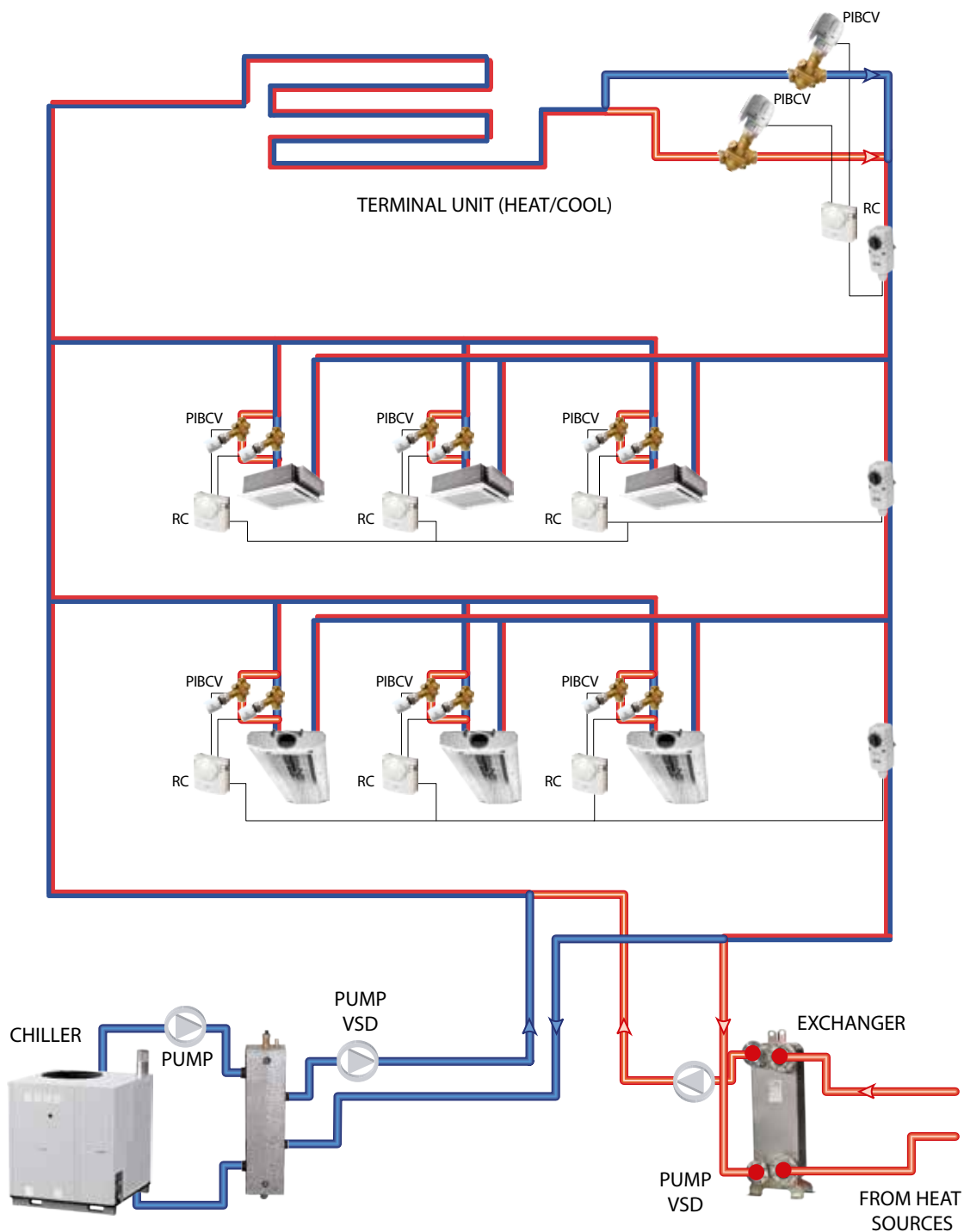

PIBCV – Pressure Independent Balancing Controller Valves
RC – Room Controller
VSD – Variable Speed Drive

*Recommended – correct engineering, high efficiency

1

Design / Sizing

- **SIMPLE CALCULATION METHOD**: no Kvs, authority or hydraulic presetting calculation
- **AUTHORITY 100%** – pressure independent control for all terminal unit, both in heating and cooling period independently from each other
- Simplified flow setting calculation according to heating and cooling demand
- Sizing of distribution pipeline according to bigger flow demand (generally cooling)
- Pump head calculation – separately for heating and cooling – according to min. Δp demand on PIBCV and system + terminal unit pressure loss at heating/cooling nominal flow
- The flow rate of heating and cooling can deviate from each other significantly

2

Operational cost

- **LOWEST** pumping costs ^{F)} (no overflow phenomenon, pressure loss of pipeline is very small at smaller flow rate – generally heating)
- Heat losses is bigger a bit in heating season due to bigger pipe dimension and slower stream
- Low pump head demand (especially in heating)
- Optimization of pump head ^{J)} is recommended
- Control valves – **100% AUTHORITY** and best efficiency
- Re-commissioning ^{C)} of the system is not required
- Does not run heating and cooling at the same time

3

Investment

- Investment cost ^{I)} – **LOW** (2 pcs. PIBCV for balancing and control, no more valves needed)
- Only two pipes (instead of four), no more hydraulic element in the system
- Two valves for each terminal unit (small installation ^{I)} cost – less pipeline)
- Commissioning of the system not required ^{B)} only flow setting
- Variable speed pump ^{S)} is recommended

4

Designed ready for installation

- Is **NOT POSSIBLE TO HEAT AND TO COOL AT THE SAME TIME**, NOT able to fulfil the "A" classification ^{X)} requirement
- Hydraulic regulation only in terminal units with 100% authority
- Balancing at full and partial load – **EXCELLENT**, exact flow limitation both, in heating and cooling period
- Minimum room temperature oscillation ^{K)}
- Variable speed pump ensures highest energy saving ^{T)} Pump optimization is recommended

5

Other

- No overflow phenomenon ^{L)}
- Minimal total energy consumption, **MAXIMUM ENERGY SAVING**
- Electrical switch must apply to avoid heating In case of cooling demand and vice versa



2.1.7

Constant flow solar systems, typical application for collectors – mainly for domestic hot water preparation and preheating of heating water

(In this application we ensure constant flow in the system, precise water distribution and flow limitation among collectors independently from number, size and location of collectors)

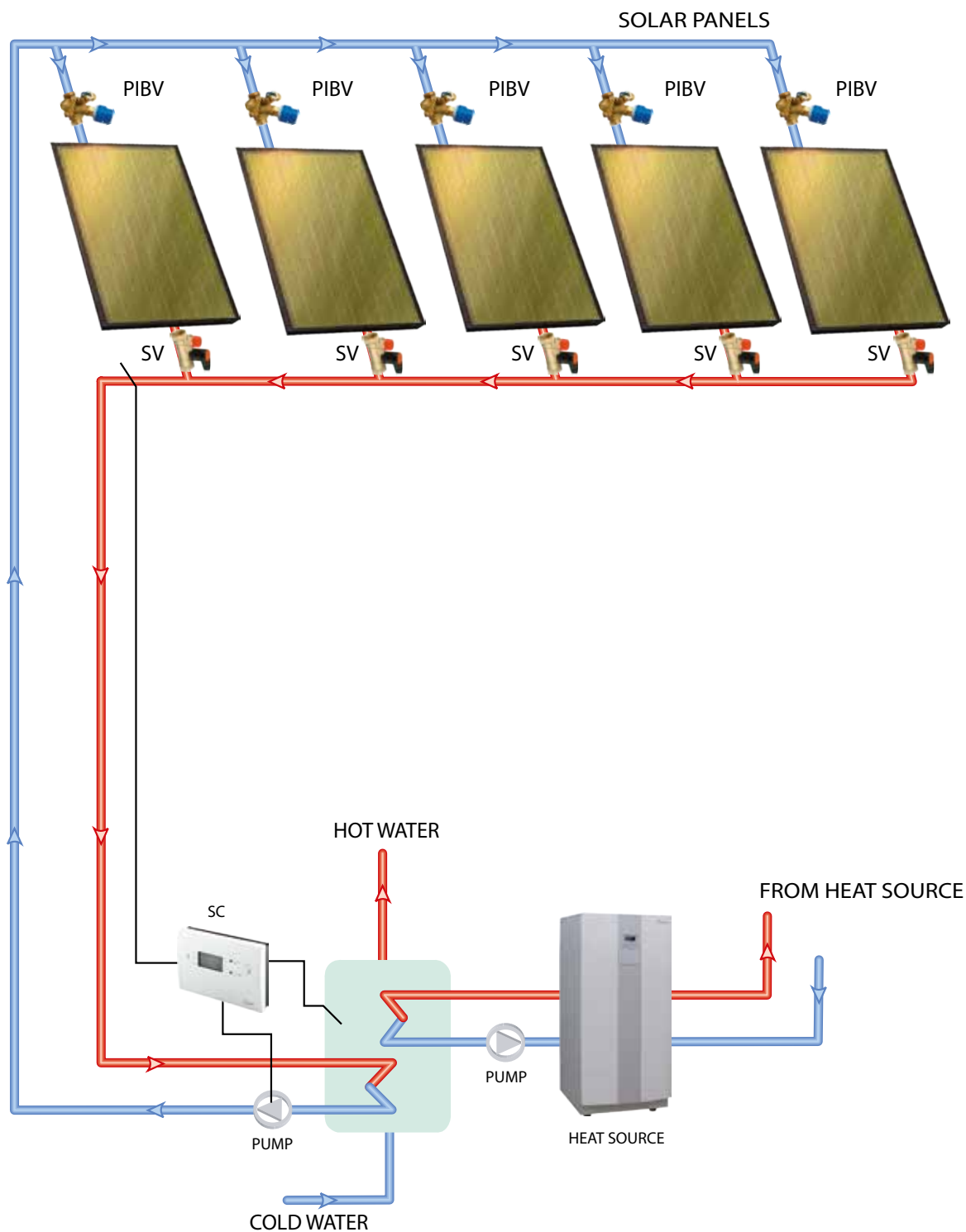

PIBV – Pressure Independent Balancing Valve (as a flow limiter)
SV – Shut-off valve
SC – Solar controller

*Recommended – correct engineering, high efficiency

1

Design / Sizing

- **SIMPLE CALCULATION METHOD:** no Kvs or hydraulic presetting calculation
- **EASY** selection of automatic flow limiters (based on flow demand)
- Simplified flow setting according flow demand
- Pump head calculation according to min. Δp demand on PIBV + collector + pressure drop in the system at nominal flow
- Variable speed drive is worth considering – if the selected pump curve is far from the requested pump head

2

Operational cost

- **MEDIUM** pumping costs ^{F)} (no overflow phenomenon)
- Higher pump head demand (the min Δp demand of PIBV is higher than manual balancing valve)
- With variable speed drive we are able to reduce the pump energy consumption
- Re-commissioning ^{C)} of the system is not required

3

Investment

- Investment cost – **MEDIUM** – (only PIBV is used at each collector, further hydronic elements are not needed)
- Commissioning of the system not required
- The least possible number of valves in the system – low installation costs
- **SIMPLE AND QUICK** pump optimization – in case of variable speed drive
- Variable speed drive is not needed if pump curve is close to required pump head

4

Designed ready for installation

- Hydraulic regulation only at collectors with setting of flow rate on PIBV
- Guaranty of the proper flow distribution among collectors
- Balancing is – **EXCELLENT**
- Commissioning not required at all –not even after system extension or change
- Fixed pumping during whole operation

5

Other

- PIBV extended with actuator ensures zone control in case of capacity reduction demand or in case of other purpose
- We have to take into consideration the max. temperature. In general such solar systems the temperature exceed the normal level.
- The glycol content of media must be defined
- Simple solar heat regulator ensures optimal energy preparation.



2.1.8

Chiller application – primary variable flow⁰⁾ system with headered pumps and controlled minimum required flow through the chiller plant

(Modern application of variable primary only flow with minimum bypass flow. Very high efficiency system.)

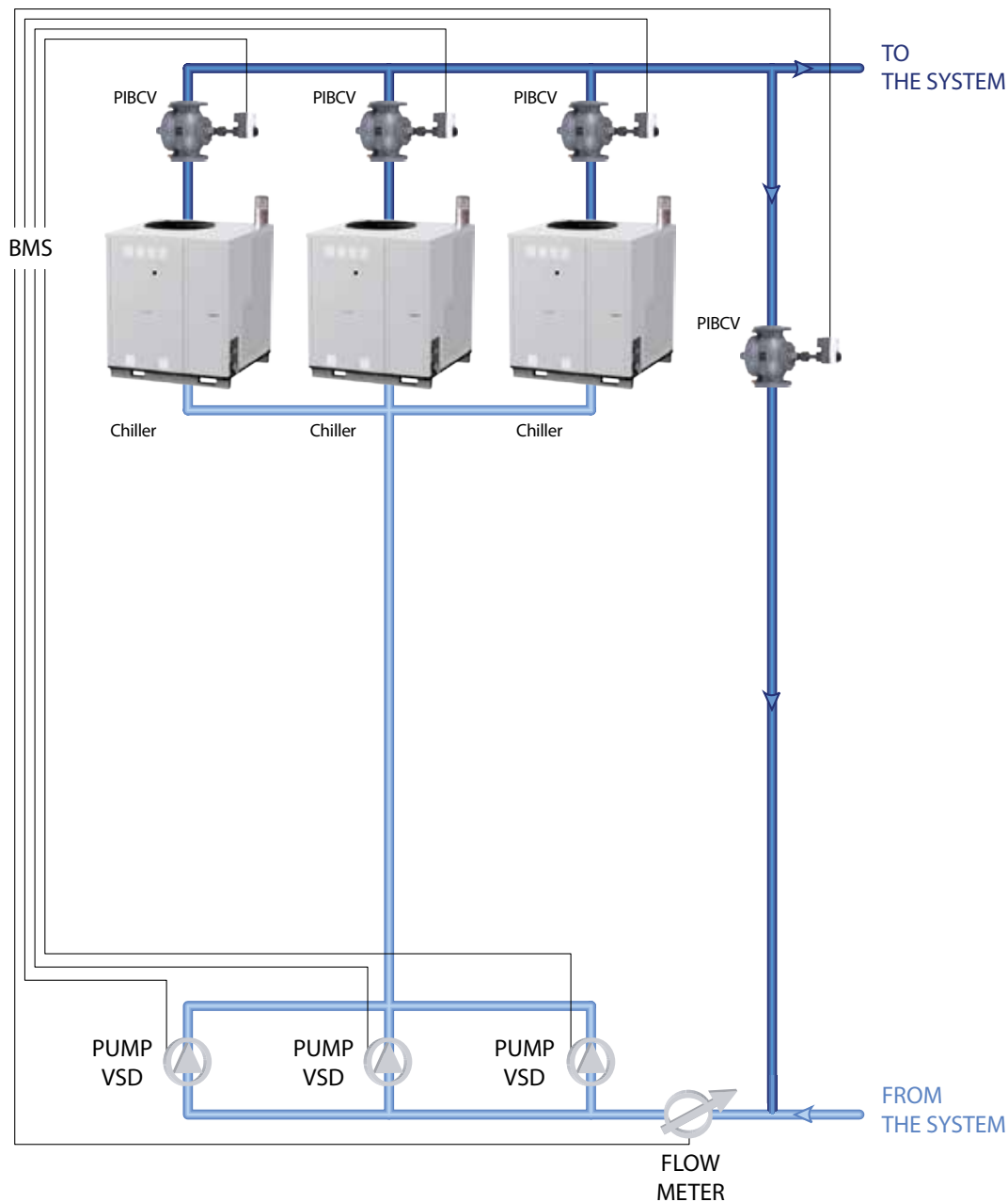

PIBCV – Pressure Independent Balancing & Control Valves
BMS – Building Management System
VSD – Variable Speed Drive

*Recommended – correct engineering, high efficiency

1

Design / Sizing

- PIBCV size in chiller loops must be fit to capacity of it and set accordingly
- Pump head calculation according to nominal flow through the entire system (variable primary flow system)
- By-pass flow calculation based on chiller minimum flow requirement – in case of more chiller, the biggest min. rate is the standard
- Complex system control (harmonization of pumps, PIBCVs and min. flow on by-pass based on flow meter)

2

Operational cost

- Possible **LOWEST** pumping costs^{F)} (chiller primary variable flow system)
- Accurate flow temperature, low Δt syndrome avoided^{H)}
- **HIGH EFFICIENCY** of the chiller machine
- Optimization of pump^{J)} head
- Minimum by-pass rate

3

Investment

- Investment cost compared to traditional system^{I)} – lower – no decoupler, no secondary pump needed
- Variable speed pump^{S)} needed

4

Designed ready for installation

- Hydraulic regulation by entire chillers independently from each other with **100% AUTHORITY**
- Balancing at full and partial load – **EXCELLENT**
- Commissioning not required at all
- Variable speed pump ensures highest energy saving^{T)}
- Exact flow temperature

5

Other

- Pressure independent chiller control with linear or logarithmic valve characteristic (linear characteristic with full authority, compensating linear piping system characteristic)
- No overflow^{L)} in the chiller plant – the idea of this system is to increase efficiency of the chiller with flows higher as designed flow.
- Reliable and highly efficient system (if the secondary side is controlled by PIBCV)



2.1.9

Variable flow system, typical application in FCU, surface and other type of combined heating/cooling systems with self acting room temperature controller

(In this application variable flow in the distribution pipeline and constant differential pressure on either branches independently from pressure oscillation in the system. With this we reduce most of the unnecessary overflow and noise problem in part load operation.)

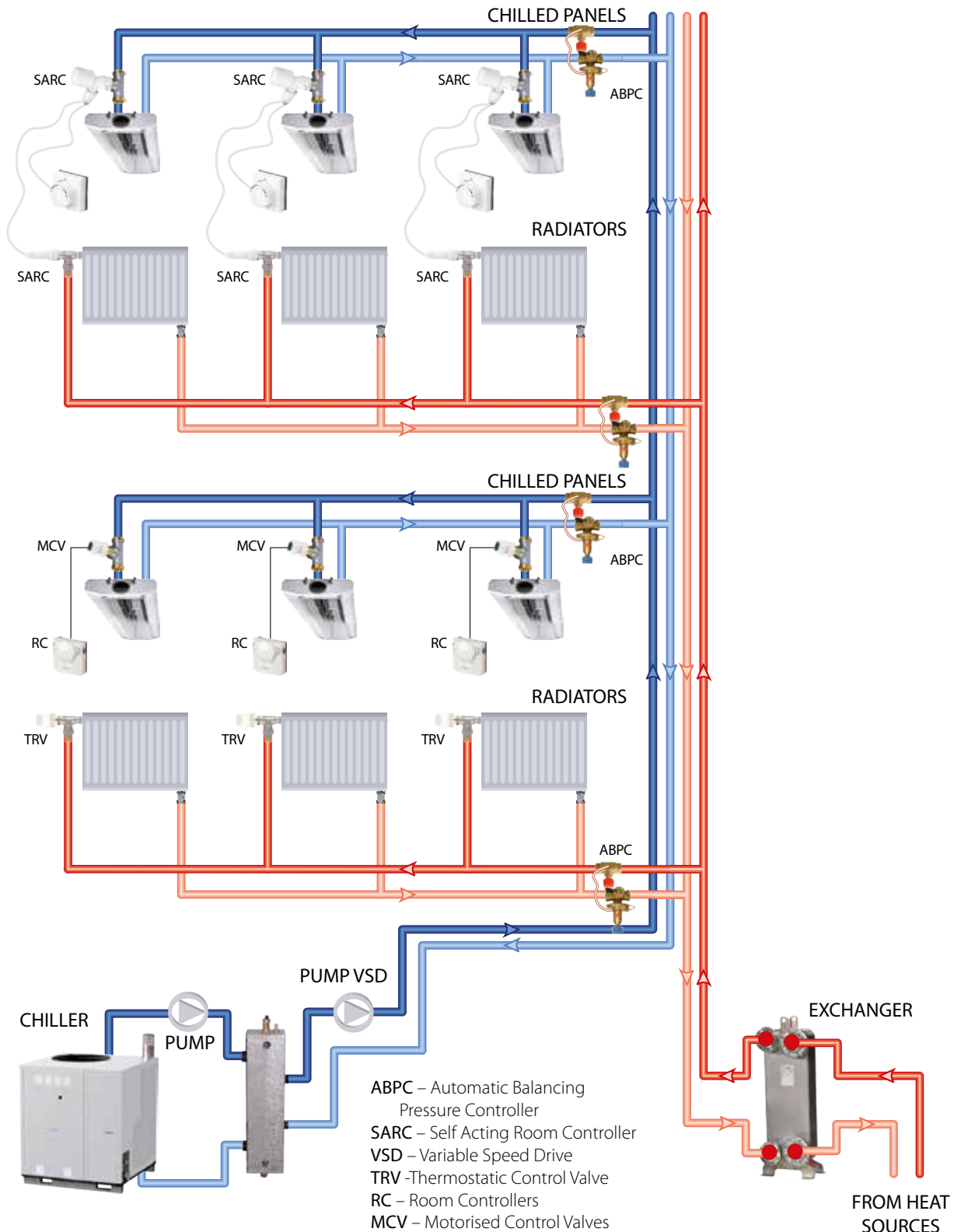

*Recommended – correct engineering, high efficiency

1

Design / Sizing

- **TRADITIONAL CALCULATION^{A)} REQUIRED FOR SELF ACTING CONTROL VALVES:** Kvs and authority of the valve
- Simplified hydraulic calculation (you can split the system according to the Δp controlled loop)
- Presetting calculation within the controlled loop is needed
- Pump head calculation according to nominal flow

2

Operational cost

- **LOW** pumping costs F) (limited loop length due to risk of the overflow phenomenon)
- Heat losses and heat gains on the pipeline are very small
- Higher pump head demand – extra pressure loss Δp controller required
- Optimization of pump^{J)} head is practical
- Self acting (proportional) control valves – low room temperature oscillation^{K)}
- **RE-COMMISSIONING^{C)}** of the system is not required
- High boiler and chiller machine efficiency due to big ΔT in the system

3

Investment

- Investment cost^{I)} – **HIGH**, regarding to the control equipments (cheap 2 port valves + SARC; ABPC by loops and furthermore moisture sensor in case of surface cooling)
- **LESS** installation costs^{J)} – electronic wiring is not needed
- Commissioning of the system not required^{B)} only simple presetting
- Variable speed pump^{S)} is recommended (constant characteristic)

4

Designed ready for installation

- Stable room temperature^{V)} (SARC), high comfort
- Hydraulic regulation only at terminal units, the Δp on the control valve nearby is constant
- Balancing at full and partial load – **GOOD**
- Variable speed pump, and good boiler/chiller efficiency ensure energy saving^{T)}
- Branch flow limitation is solved by presetting the control valves

5

Other

- Closing pressure of zone valves should be 50% more than pressure setting on Δp controller
- Slight overflow during partial load condition (self acting controller compensates it)
- Usually pump oversized and overloaded to achieve normal authority on SARC
- Moisture sensor needed for surface cooling to avoid condensation in the room



2.1.10

Variable flow system, typical application in two pipe heating system riser control without thermostatic radiator valve

(In this application we ensure constant flow on subordinated risers, no thermostatic radiator valve (like staircase, bathroom etc.) but in case of partial load condition when the return temperature is increasing the flow become variable on these risers based on return flow temperature control. /Two risers on the right on sketch below/)

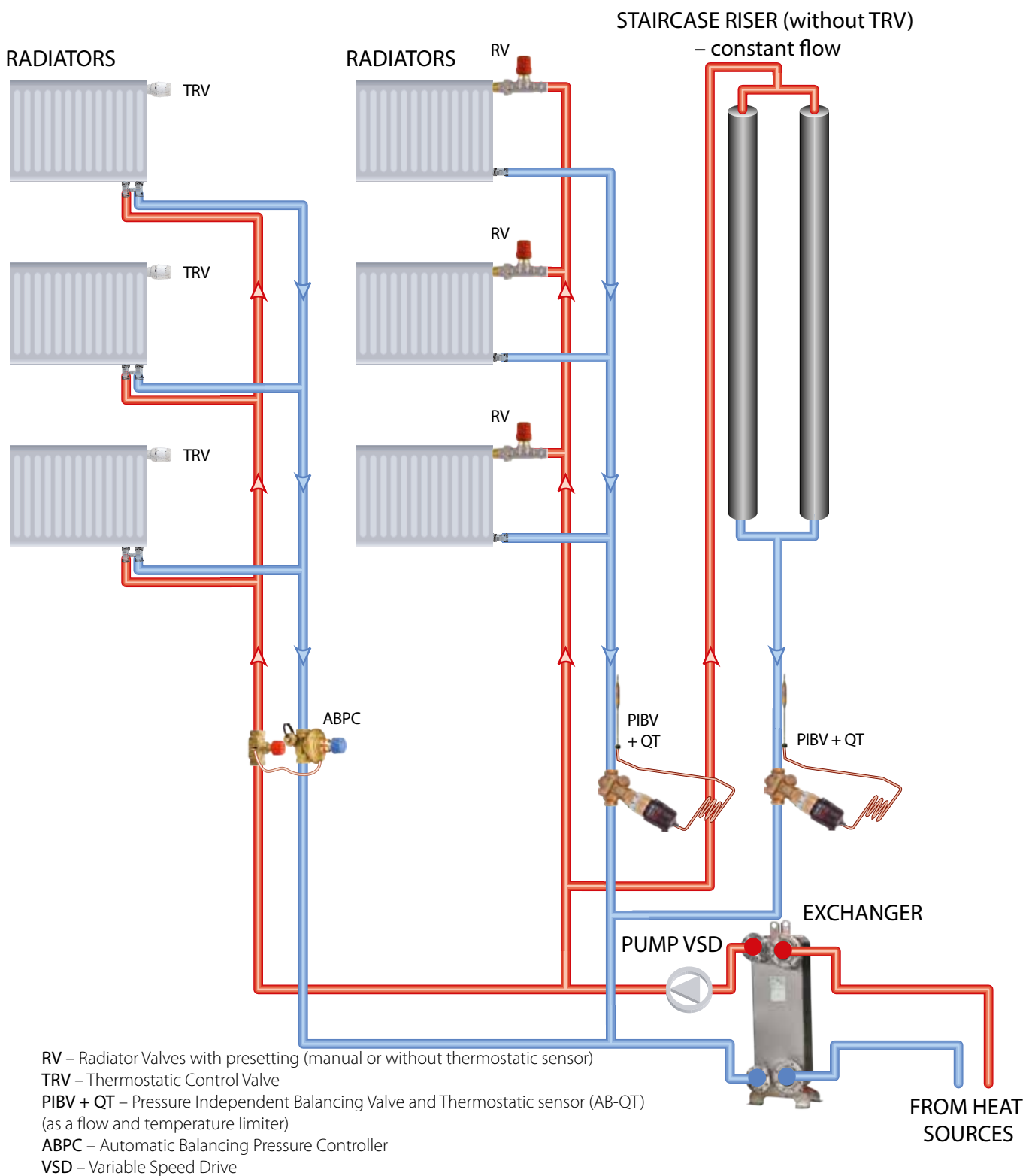

*Recommended – correct engineering, high efficiency

1

Design / Sizing

- **UNIQUE CALCULATION REQUIRED FOR RISER FLOW DEMAND:** with flow and temperature limiter in return pipe we are able to ensure such min. ΔT on risers what we expect. The size of radiator, convector has to be accordingly.
- The presetting calculation of terminal units within the loop is crucial due to no room temperature control, the heat emission will be according flow rate and size of radiator. The presetting calculation based on flow demand rate among radiators and pressure drop of pipeline within controlled loop
- Simplified hydraulic calculation (you can split the system by risers) but has to take into consideration the Δp demand of AB-QT valve
- Pump head calculation according to nominal flow

2

Operational cost

- **LOWEST** pumping costs^{F)} – the flow rate of subordinated risers limited also and reduce further according temperature limitation
- Possible **BIGGEST ΔT** on risers – heat losses on the pipeline are small, more efficient boiler or heat exchanger operation
- Less overheating of risers
- Higher pump head demand – bigger pressure drop on flow limiter
- Optimization of pump^{J)} head is practical

3

Investment

- Investment cost^{I)} – **ACCEPTABLE** (ABV by loops but no individual temperature control)
- QT temperature limiter is extra cost
- Less valves than manual application, lower installation costs^{I)} in spite of QT installation
- Commissioning^{B)} of the system not required only setting of flow and temperature
- Variable speed pump^{S)} is recommended (constant characteristic)

4

Designed ready for installation

- Hydraulic regulation is in the bottom of risers only.
- The flow rate on radiators according presetting and the changes of it is proportional according closing of QT
- Balancing at full and partial load – **GOOD** – additional energy saving
- **HIGH EFFICIENCY:** maximized ΔT on riser and variable speed pump ensures energy saving^{I)}

5

Other

- Inner rooms (typically bathrooms) heat demand is constant, the needed flow rate decreasing when (outdoor temperature falls and) flow temperature increasing
- In case of increasing return temperature the QT element closes by self acting controller and retain flow outside from riser



2.1.11

One pipe radiator heating systems with thermostatic radiator valves and automatic return temperature limiter

(In this application we ensure automatic flow limitation in the risers with PIBCV and restrict the flow on it – in case of lower outdoor temperature – when TRVs are closing in partial load condition.)

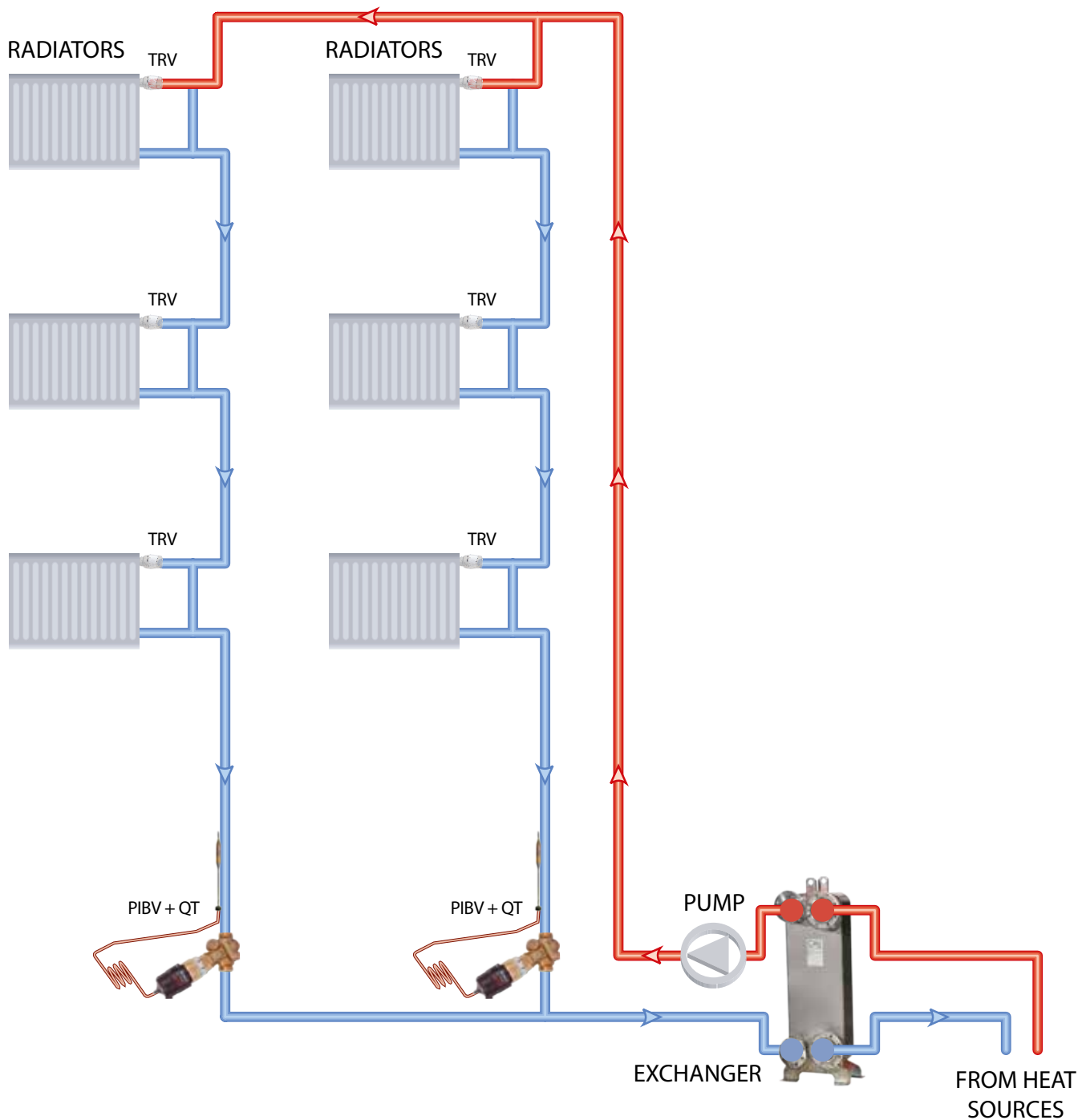

TRV – Thermostatic Control Valves
PIBV + QT – Pressure Independent Balancing Valve and Thermostatic sensor (AB-QT) (as a flow and temperature limiter)

*Recommended – correct engineering, medium efficiency

1

Design / Sizing

- Special calculation method regarding “ α ” (radiator share) and radiator size. The kv value (capacity) of TRV should be taken in to consideration.
- (Heat loss calculation on vertical pipelines)
- **SIMPLIFIED HYDRAULIC CALCULATION (CONCERNING WATER DEVIATION AMONG RISERS)**
- Presetting calculation of TRV is not needed
- Setting of QT element depends on more factors* like (renovation effectiveness, no. of floors, etc.)
- Pump head calculation according to nominal flow

2

Operational cost

- **MEDIUM** pumping costs ^{f)} although the system is variable flow system during QT element closes
- Heat losses on the pipeline are high (but limited with QT) but most of them utilized inside the room (vertical pipeline)
- Higher pump plus minimum Δp demand of AB-QM head demand – long pipeline and relatively small Kv value of by-pass ^{j)}
- Optimization of pump head is possible (with measuring nipple on AB-QM) and VSD
- QT element saves energy as the return temperature is limited

3

Investment

- Investment cost ^{l)} – **MEDIUM** (TRV + PIBV + QT by risers)
- Less valves than in case of manual balancing, lower installation costs ^{l)}
- QT installation and set is simple
- Commissioning ^{m)} of the system not required (only setting of PIBV)
- Variable speed pump ⁿ⁾ is considerably

4

Designed ready for installation

- Hydraulic regulation only at bottom of riser - the flow demand varying based on QT operation
- Balancing at full and partial load – **GOOD**
- Low room temperature oscillation ^{o)} – self acting control, although the heat transfer from the pipeline will effect onto this
- The return temperature is limited with QT element (at lower outdoor temperature)

5

Other

- Closing pressure of TRV pretty low – generally max 0,6 bar is enough, functions best between 0,1 to 0,3 bar.
- In partial load condition QT element closes when return temperature increasing due to closing TRV (at low outdoor temperature)
- High QT setting ensures safe operation, low QT setting ensures more energy saving



2.1.12

One pipe horizontal heating systems with thermostatic radiator valves and automatic return temperature limiter

(In this application we ensure automatic flow limitation for all heating circuits and limit the return temperature to avoid small ΔT in the loops during partial load, in case of lower outdoor temperature.)

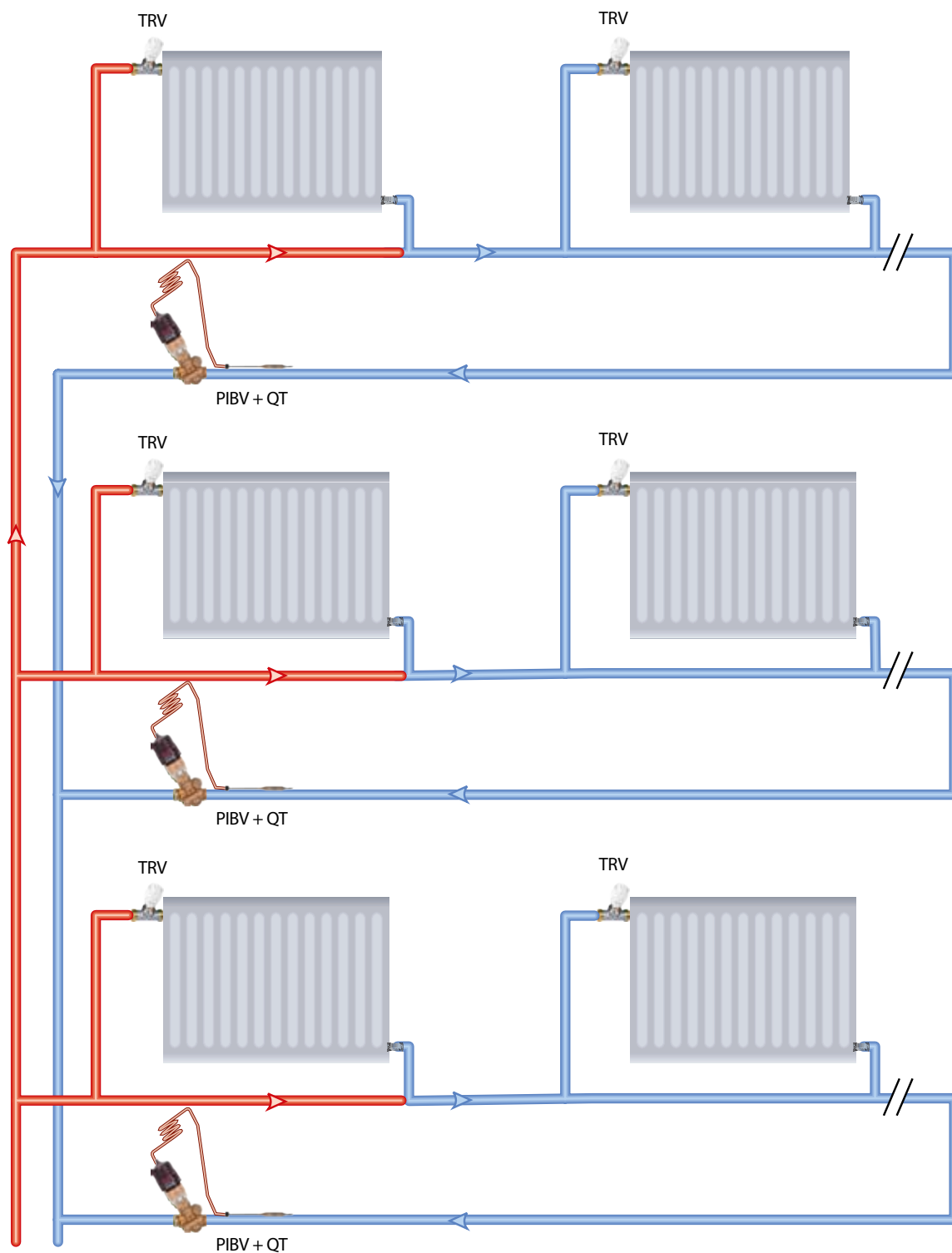

TRV – Thermostatic Control Valves

PIBV + QT – Pressure Independent Balancing Valve and Thermostatic sensor (AB-QT) (as a flow and temperature limiter)

*Recommended – correct engineering, medium efficiency

1

Design / Sizing

- Traditional radiator connection (upper part of sketch left side): Special calculation method regarding “ α ” (radiator share) and radiator size. The kv value (capacity) of TRV should be taken into consideration.
- With valve two point radiator connection (lower part of sketch left side): The defined “ α ” influences the max number of applicable radiators. (Mixing temperature calculation after each radiators)
- **SIMPLIFIED HYDRAULIC CALCULATION (CONCERNING WATER DEVIATION AMONG RISERS)**
- TRV presetting calculation is not needed
- Return temperature setting on QT element according system feature
- Pump head calculation according to nominal flow

2

Operational cost

- **HIGHER** pumping costs ^{F)} although the system is variable flow system during QT element closes the PIBV
- Heat losses on the pipeline are high, few rate of them utilized inside the room (depends on piping)
- QT element saves energy
- Higher pump head demand, plus minimum Δp of AB-QM – long pipeline, more valve in line – in spite of relatively high Kv value of TRV
- Optimization of pump head is recommended (with measuring nipple on PIBV) and VSD ^{S)}

3

Investment

- Investment cost ^{I)} – **HIGH** (TRV + PIBV + QT by risers)
- Less valves than in case of manual balancing, lower installation costs ^{I)}
- Simple QT installation and setting. (Re-set recommended based on operational experience)
- Commissioning ^{B)} of the system not required (only setting of PIBV and QT)
- Variable speed pump ^{S)} is recommended

4

Designed ready for installation

- Low room temperature oscillation ^{K)} – self acting control based on room temperature (small Xp value)
- Flow restriction in loop via QT element when return temperature increasing
- Hydraulic regulation only at bottom of riser – loop flow demand is varying according partial load condition
- Balancing at full and partial load – **GOOD**

5

Other

- Closing pressure of TRV pretty low – generally max 0,6 bar is enough, functions best between 0,1 to 0,3 bar.
- Flow reduction in the system during partial load condition when return temperature increases due to partial load (the TRVs are closing)



2.1.13

Variable flow system, typical application in two pipe surface (floor or wall) heating systems with manifolds and individual room controller

(In this application we ensure variable flow in the distribution pipeline and constant differential pressure on either manifold independently from temporarily load and pressure oscillation in the system.)

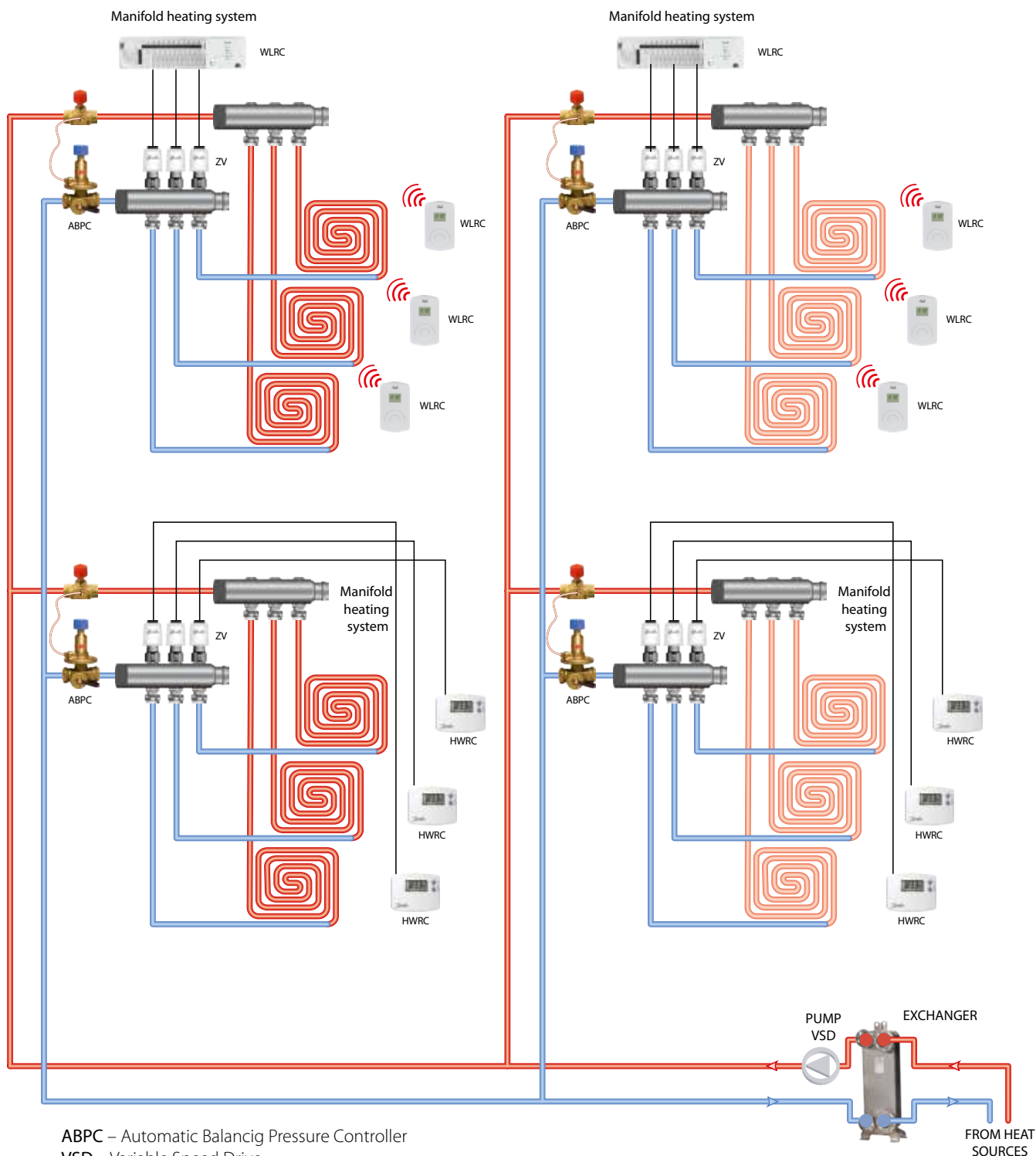

- ABPC – Automatic Balancing Pressure Controller
- VSD – Variable Speed Drive
- WLRC – WireLess Room Controller
- HWRC – Hard Wired Room Controller
- ZV – Zone Valve

*Recommended – correct engineering, high efficiency

1

Design / Sizing

- **TRADITIONAL CALCULATION^{A)} REQUIRED FOR PRESETTABLE VALVE IN ENTIRE LOOPS:** Kv of presetting, pressure loss calculation
- Presetting calculation concerning control valve within the Δp controlled loop
- Simplified hydraulic calculation (you can split the system according to Δp controlled branches)
- Simple ΔP controller calculation : recommended 10 kPa pressure drop on it
- Pump head calculation according to nominal flow

2

Operational cost

- **LOW** pumping costs^{F)}
- Heat losses on the distribution pipeline are small
- Higher pump head demand – extra pressure loss on Δp controller required
- Optimization of pump^{J)} head is practical
- Typically ON/OFF control with big heat storage surface, higher room temperature oscillation^{K)}

3

Investment

- Investment cost^{L)} – **GOOD** (zone control valve + ABV in front of each manifold)
- A little more expensive Δp controllers
- Less valves than manual application, less installation^{M)} costs
- Commissioning^{N)} of the system generally not required
- Variable speed pumps^{S)} are recommended (constant characteristic)

4

Designed ready for installation

- Hydraulic regulation only at manifolds. The Δp on it nearby constant
- Balancing at full and part load – **GOOD** – good, lower room temperature is applicable
- Variable speed pump ensure energy saving^{T)}

5

Other

- Closing pressure of zone valve should be 50% higher as set Δp on APBC
- Minimal overflow during partial load condition (constant differential pressure on each loop)



2.1.14

Two pipe horizontal heating systems with individual flat connection, including thermostatic radiator valves, automatic pressure difference controller and zone control

(In this application we ensure automatic flow limitation for all flats, automatic pressure difference control for heating circuits and (programmable) zone control with one valve.)

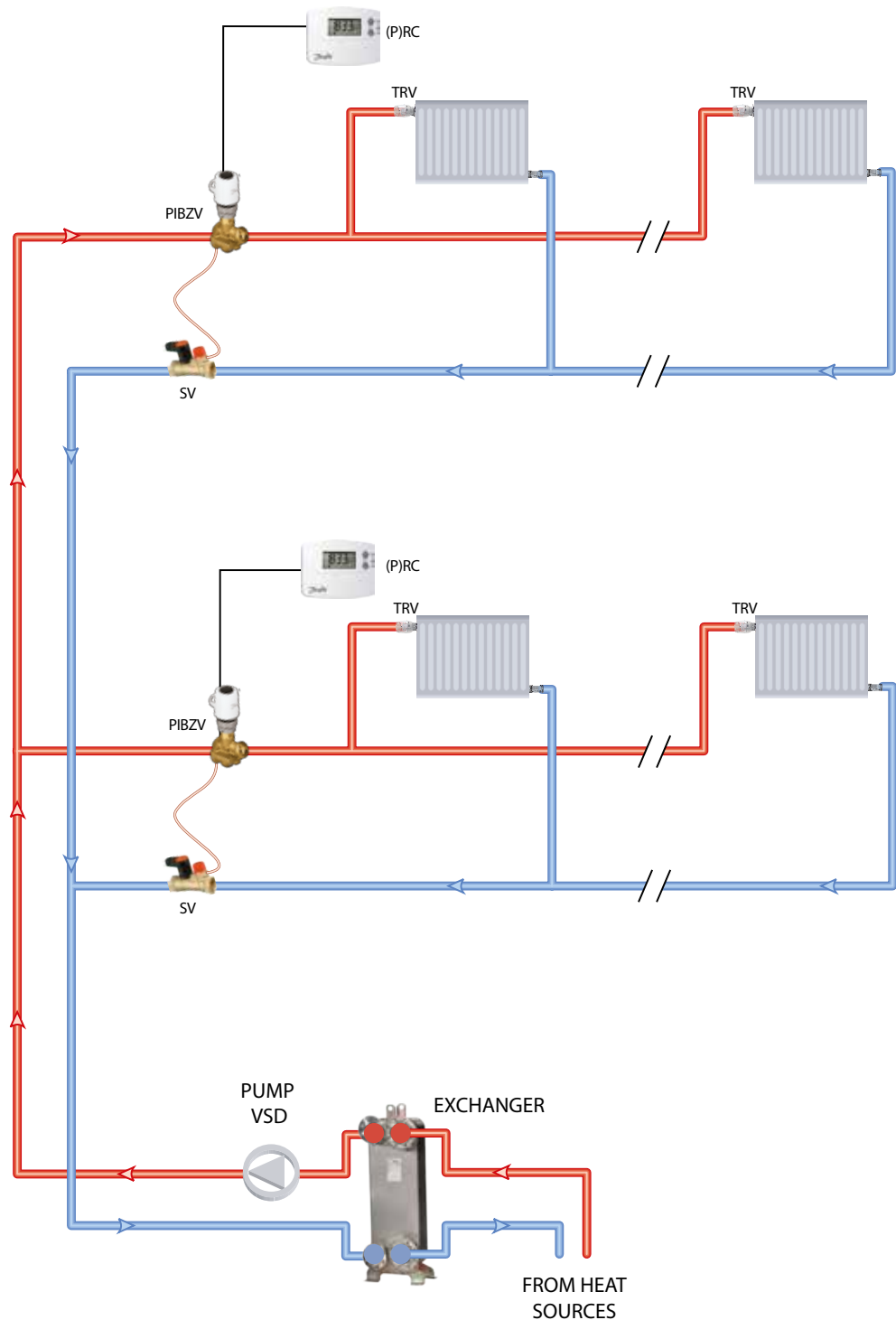

- TRV – Thermostatic Control Valves
- PIBZV – Pressure Independent Balancing and Zone Valves (AB-PM)
- (P)RC – (Programmable) Room Controller
- VSD – Variable Speed Drive
- SV – Shut-off valve

*Recommended – correct engineering, high efficiency

1

Design / Sizing

- **TRADITIONAL CALCULATION ^{A)} REQUIRED FOR TRV:** Kv (presetting) value
- Presetting calculation concerning hydronic system within the Δp controlled loop
- Simplified hydraulic calculation of distribution pipeline (you can split the system according to location of Δp controller)
- Precise flow limiter- ΔP controller calculation is needed based on sizing diagram: The presetting of PIBZV valve depends on flow demand and pressure loss of controlled loop
- Pump head calculation according to nominal flow
- The zone control is additional function, in this case thermostat and ON/OFF actuator are needed

2

Operational cost

- **REDUCED ENERGY CONSUMPTION** of flats, TRV ensures the utilization of free heat, zone valve saves energy based on time control
- TRV – generally achieves good authority ^{E)} – has self acting control, lower room temperature oscillation ^{K)}
- Low pumping costs ^{F)}
- Heat losses on the distribution pipeline are small
- Higher pump head demand – extra pressure loss on PIBZV is required
- Optimization of pump ^{J)} head is recommended

3

Investment

- Investment cost ^{I)} – **GOOD** (ABV in front of all flats + flow limitation + zone control with one valve)
- Very good price-performance rate (PIBZV more expensive than manual balancing valve)
- Less valves than manual application, less installation ^{L)} costs
- Commissioning ^{B)} of the system not required only presetting of PIBZV and TRV according desing
- Variable speed pump ^{S)} is recommended (proportional characteristic)

4

Designed ready for installation

- Minimum room temperature oscillation ^{K)} self acting control with designed proportional band
- The Δp on the TRV is nearby constant, due to flow limitation no overflow in the system
- Balancing at full and part load – **GOOD** – excellent comfort, programmable room temperature possibility
- Variable speed pump ensures energy saving ^{T)}

5

Other

- Closing pressure of TRV should be 22 kPa only – according working condition of PIBZV
- Heat cost allocation is possible in case of usage of heat meter at flats (heat meter must be outside of Δp controlled loop)
- Overflow on radiators very limited (depends on pressure loss changing – of distribution pipeline inside the Δp controlled loop – during partial load condition)



2.1.15

Variable flow system, typical application in flat station business

(In this application we ensure variable flow in the primary (distribution) network and flow limitation in part of buildings to take into consideration the simultaneity.)

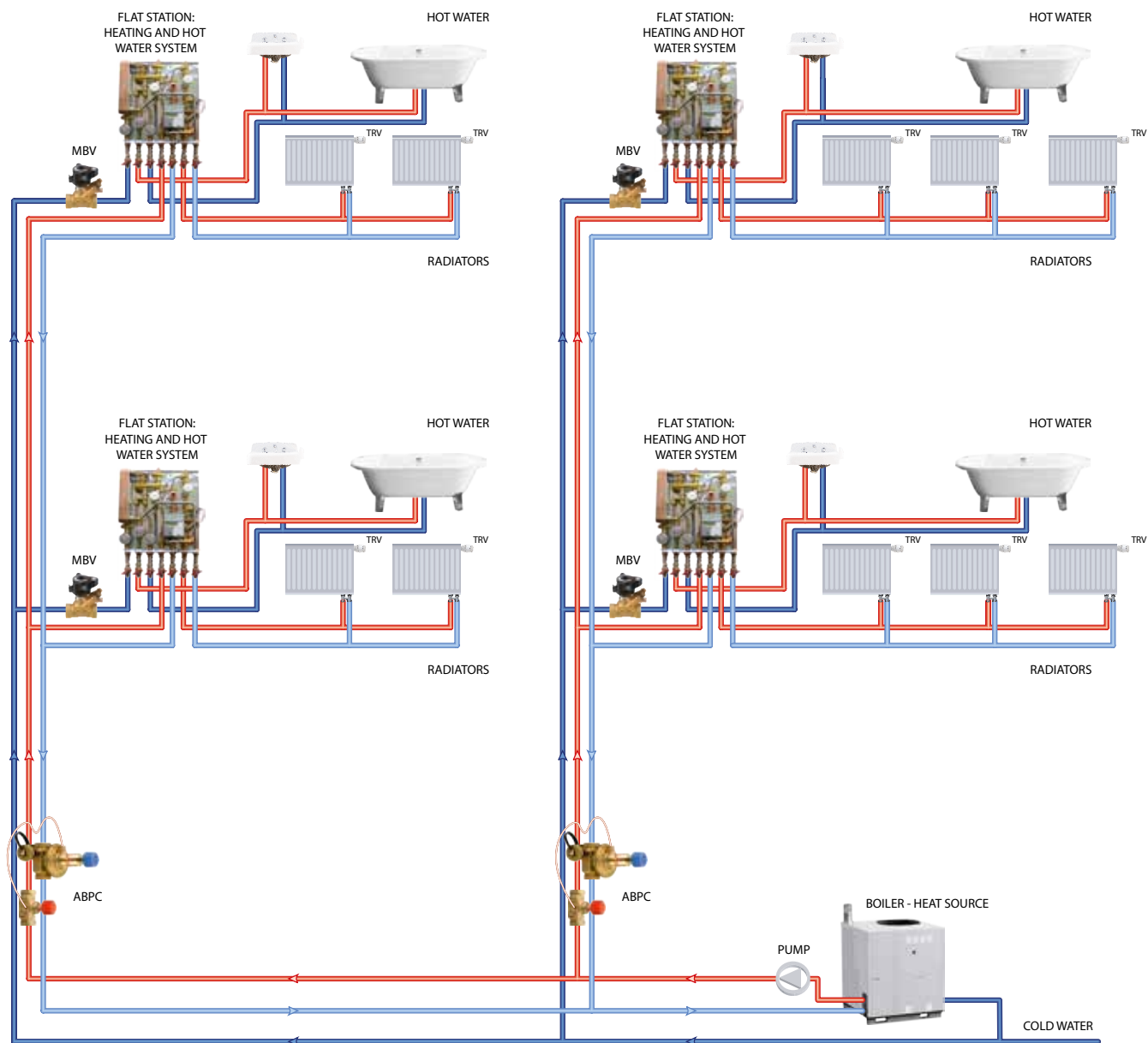

MBV – Manual Balancing Valve
 TRV – Thermostatic Control Valves
 ABPC – Automatic Balancing Pressure Controller

*Recommended – correct engineering, high efficiency

1

Design / Sizing

- The Δp demand of flat station is given
- The flat station is equipped with Δp controller for heating circuit (it is saved against overpressure)
- **SPECIAL HYDRAULIC CALCULATION IS NEEDED FOR PIPELINE:** the size of pipeline depends on coincidence factor
- Presetting calculation regarding radiators in secondary side within the Δp controlled loop
- Hydraulic calculation concerning Δp controller: Δp setting (flat station+pipeline) + flow limitation (according to simultaneity)
- Simple ΔP controller calculation : recommended 10 kPa pressure drop on it
- Pump head calculation according to pressure losses with coincidence factor
- Flat pump characteristic is advantage, VSD not recommended if only with very fast reaction (due to very fast load changes in the system based on DHW fluctuation)

2

Operational costs

- **MEDIUM** pumping costs^{F)} (variable flow but rather high pump head demand)
- Heat losses on the distribution pipeline very small (3 pipelines instead of 5)
- Higher pump head demand – high Δp demand on flat station and extra pressure loss on Δp controller + flow limiter required

3

Investment

- Investment cost^{I)} – **HIGH** – (flat station + DPC + FL in risers)
- Less pipeline and additional equipment – DHW system is missing, preparation at flats
- Commissioning is needed (set the Δp on controller and flow limitation on the riser and in front of flats on MBV)
- Variable speed pump^{S)} is recommended (constant characteristic)

4

Designed ready for installation

- Hydraulic regulation inside the flat station and bottom of the riser
- Balancing at full and partial load – **VERY GOOD**
- **HIGH COMFORT** (individual heat metering, simple system, instantaneous DHW^{M)} preparation, Δp controlled heating, self acting room temperature control with TRV, time control possibility)
- Energy efficient solution, low heat loss in the system
- Variable speed pump ensures energy saving^{T)}

5

Other

- Thermostatic radiator valve is recommended for heating
- Temperature control of DHW is pressure relieved
- Minimal overflow during partial load condition (fast reaction temperature control of DHW preparation)
- Built in by-pass into the flat station to keep the heat exchanger on hot
- When commissioning the DHW^{M)} side to avoid too much secondary flow through the heat exchanger and provide the needed tapping temperature



2.1.16

Variable flow system, typical application in ventilation heating units, air curtains etc.

(In this application we ensure variable flow in the distribution pipeline and flow limitation (or control) in the entire terminal unit independently from pressure oscillation in the system. With this we eliminate any kind of overflow during the whole operation period.)

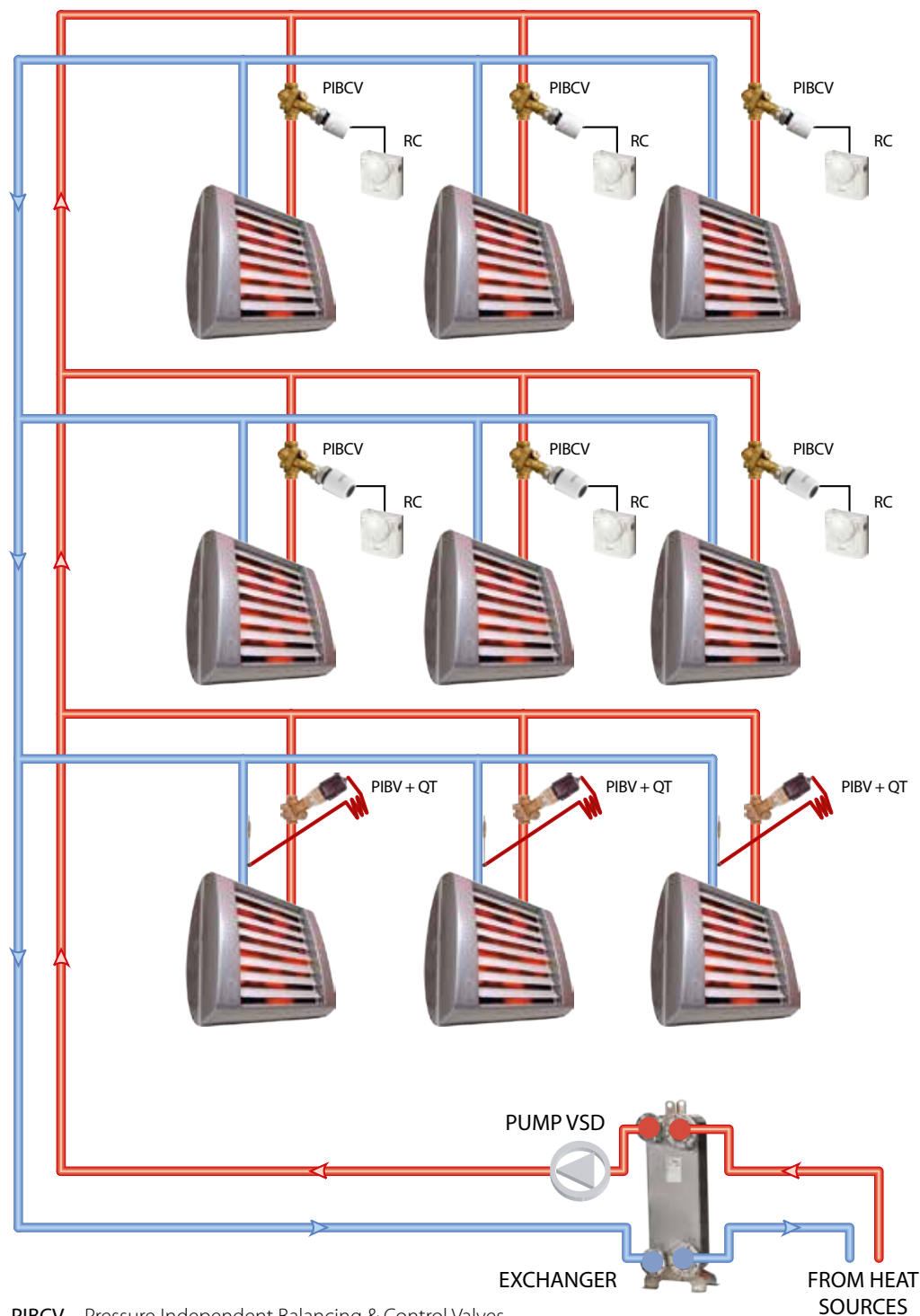

- PIBCV – Pressure Independent Balancing & Control Valves
- RC – Room Controller
- VSD – Variable Speed Drive
- PIBV + QT – Pressure Independent Balancing Valve and Thermostatic sensor (AB-QT) (as a flow and temperature limiter)

*Recommended – correct engineering, high efficiency

1

Design / Sizing

- **SIMPLE CALCULATION METHOD:** no Kvs, authority or hydraulic presetting calculation
- **AUTHORITY 100%** – pressure independent control
- Simplified flow setting calculation according to heat demand
- Pump head calculation according to min. Δp on the valve and system pressure loss at nominal flow

2

Operational cost

- **LOWEST** pumping costs^{F)} (no overflow phenomenon)
- Heat losses and heat gains on the pipeline are minimal
- Lowest pump head demand
- Optimization of pump^{J)} head is possible
- Control valves – **100% AUTHORITY** and best efficiency – minimum room temperature oscillation^{K)}
- Re-commissioning^{C)} of the system is not required

3

Investment

- Investment cost^{I)} – **GOOD – HIGH** (only 2 port PIBCV)
- No hydraulic element in the system more
- The least number of valves in the system (lower installation costs^{H)})
- Commissioning^{B)} of the system not required
- Variable speed pump^{S)} is recommended (proportional characteristic)

4

Designed ready for installation

- Hydraulic regulation only in terminal units with **100% AUTHORITY**
- Balancing at full and part load – **EXCELLENT**
- **COMMISSIONING** not required at all
- Variable speed pump ensures highest energy saving^{T)}

5

Other

- PIBCV is able to close against 6 bar
- Zero overflow^{L)}
- Easy pump optimization
- Proportional temperature control ensures more accurate room temperature and less energy consumption.
MAXIMAL ENERGY SAVING
- The QT self acting return temperature limiter is recommended for subordinated places, like storage room, etc.



2.1.17

Variable flow system with automatic temperature balancing in Domestic Hot Water circulation network

(In this application we ensure variable flow in the DHW circulation pipeline and constant tapping temperature on either taps independently from the distance from storage tank and temporary hot water usage. With this we reduce the quantity of circulation water during all periods.

Thermal disinfection is possible with additional equipment)

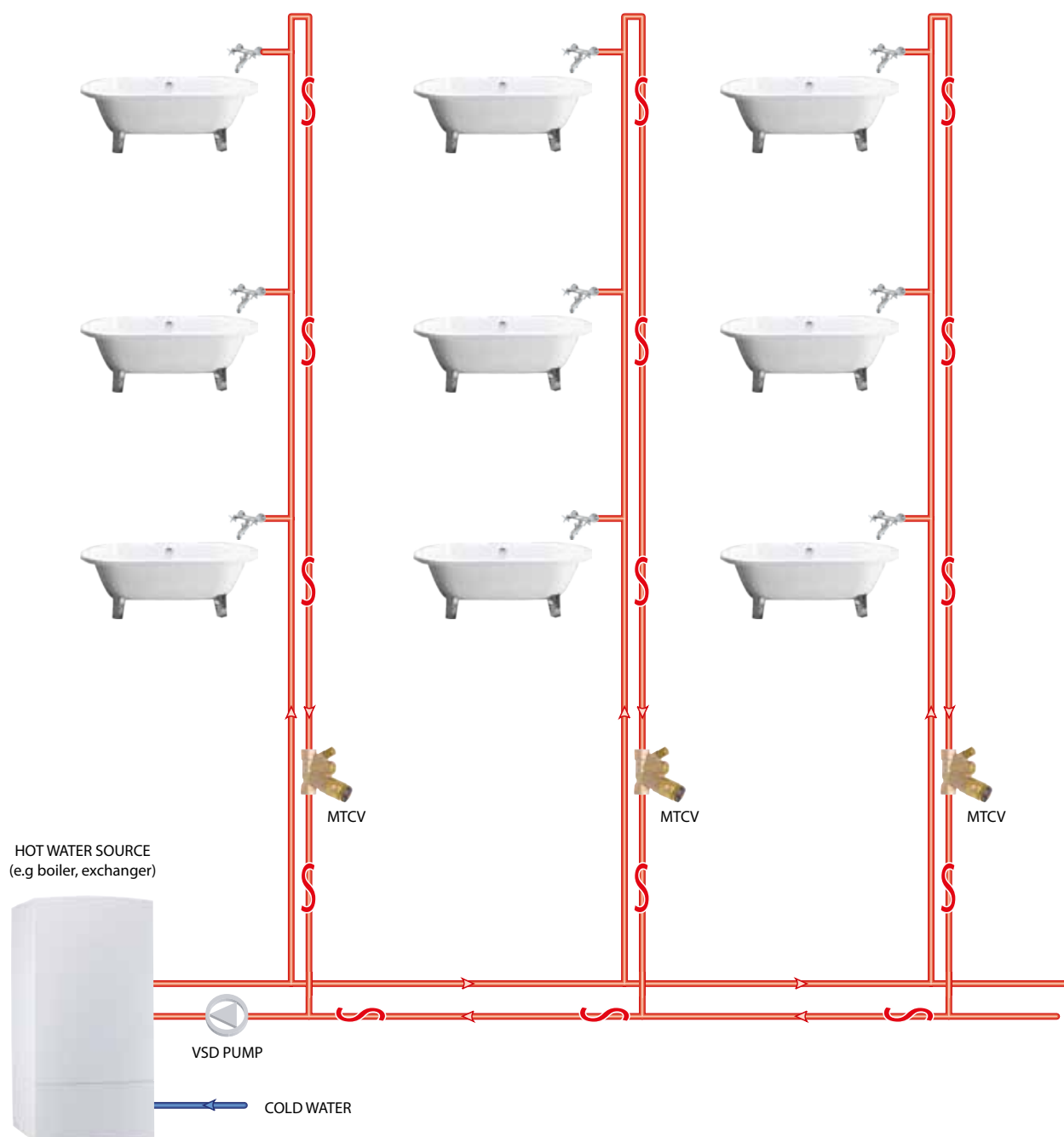

MTCV – Multifunctional Temperature Control Valve
VSD – Variable Speed Drive

*Recommended – correct engineering, high efficiency

1

Design / Sizing

- **SIMPLIFIED CALCULATION** required for self acting control valves:
 - Kvs and authority of the valve
- Simplified hydraulic calculation needed – regarding pipeline only
- Presetting calculation is not needed
- Pump head calculation according to nominal flow
- Variable Speed Drive is recommended

2

Operational cost

- **LOW** pumping costs^{F)}
- Heat losses on the circulation pipeline are minimized
- Optimization of pump^{J)} head is practical
- Self acting (proportional) control valves – ensure constant tapping temperature^{Z)}
- **RE-COMMISSIONING**^{C)} of the system is not required
- High boiler efficiency due to the bigger ΔT in the system
- Variable Speed Drive reduces the energy consumption and protects the pump

3

Investment

- Investment cost^{I)} – **MEDIUM**: MTCV more expensive as manual valve (short payback time)
- **LOWER** installation cost^{I)} – partner valve not needed^{N)}
- Commissioning of the system not required^{B)}
- Variable speed pump^{S)} is recommended (constant pressure characteristic)

4

Designed ready for installation

- Stable circulation temperature, high comfort
- Balancing at full and partial load – **VERY GOOD**
- Variable speed pump and good boiler/ chiller efficiency ensure energy saving^{T)}

5

Other

- No overflow, the circulated flow is according to temporary demand (in case of usage, the flow pipe is hot, the MTCV limit the circulation)
- Thermal disinfection is possible with additional equipment



2.1.18

Variable flow system with automatic temperature balancing in Domestic Hot Water circulation network

(In this application we ensure variable flow in the DHW circulation pipeline and constant tapping temperature on either taps independently from the distance from storage tank and temporary hot water usage. With this we reduce the quantity of circulation water in all periods. TMV valves ensure constant tapping temperature in term of thermal disinfection period too. Thermal disinfection is controlled by CCR2 electronic device. Thermal disinfection is possible with additional equipment.)

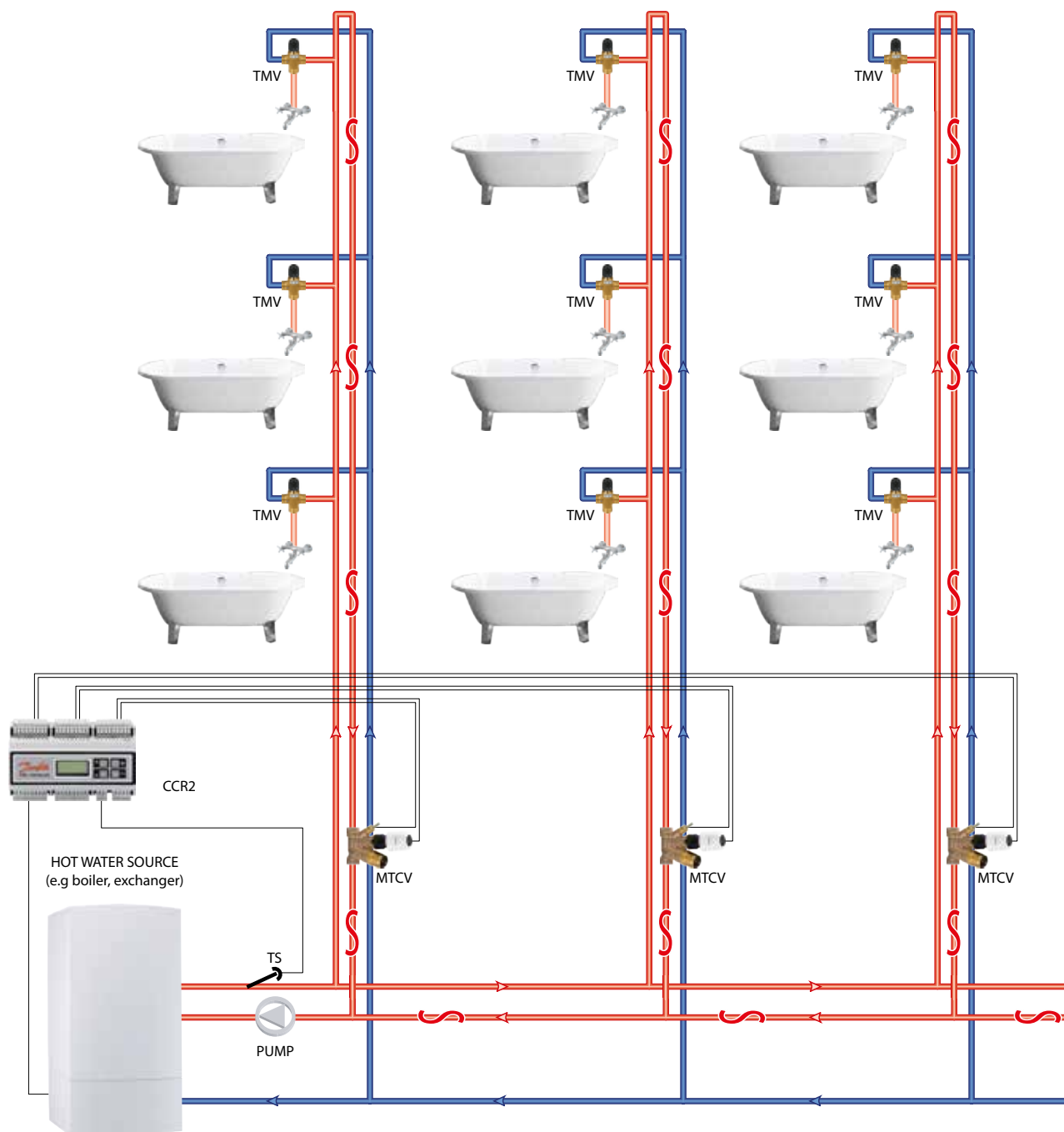

- MTCV – Multifunctional Temperature Control Valve
- TMV – Temperature Mixing Valve
- CCR2 – Data Register and Disinfection Electronic
- TS – Temperature Sensor

*Recommended – correct engineering, high efficiency

1

Design / Sizing

- **SIMPLIFIED CALCULATION** required for self acting control valves:
 - Kvs and authority of the valve
- Simplified hydraulic calculation needed – regarding pipeline only
- Presetting calculation is not needed
- Pump head calculation according to nominal flow

2

Operational cost

- **LOW** pumping costs ^{F)}
- Heat losses on the circulation pipeline are minimized
- Optimization of pump ^{J)} head is practical
- Self acting (proportional) control valves – ensure constant tapping temperature ^{Z)}
- **RE-COMMISSIONING** ^{C)} of the system is not required
- High boiler efficiency due to bigger ΔT in the system

3

Investment

- Investment cost ^{I)} – **HIGH**: regarding control equipments (more expensive MTCV and CCR2, furthermore (as option) temperature mixing valve and disinfection control)
- **LOWER** installation costs ^{I)} – partner valve not needed ^{N)}
- Commissioning of the system not required ^{B)}
- Variable speed pump ^{S)} is recommended (constant pressure characteristic)

4

Designed ready for installation

- Stable circulation temperature, high comfort
- Balancing at full and partial load – **VERY GOOD**
- Variable speed pump and good boiler/chiller efficiency ensure energy saving ^{T)}

5

Other

- No overflow, the circulated flow is according to temporary demand (in case of usage, the flow pipe is hot, the MTCV limit the circulation)
- Fair cost accounting due to similar tapping temperature
- Thermal disinfection ^{Q)} of the system is excellent –programmable and optimised
- Temperature registration is solved by CCR2
- With TVM valves we are able to limit the tapping temperature during thermal disinfection period



NOT RECOMMENDED*

Application

2.2.1

Variable flow system, often used in radiator heating, FCU heating/cooling systems and in AHU

(In this application we ensure variable flow in the distribution pipeline but we cannot ensure constant differential pressure on the terminal units. The available pressure is oscillating in the system and causes bad room temperature control, overflow and noise problem in partial load operation.)

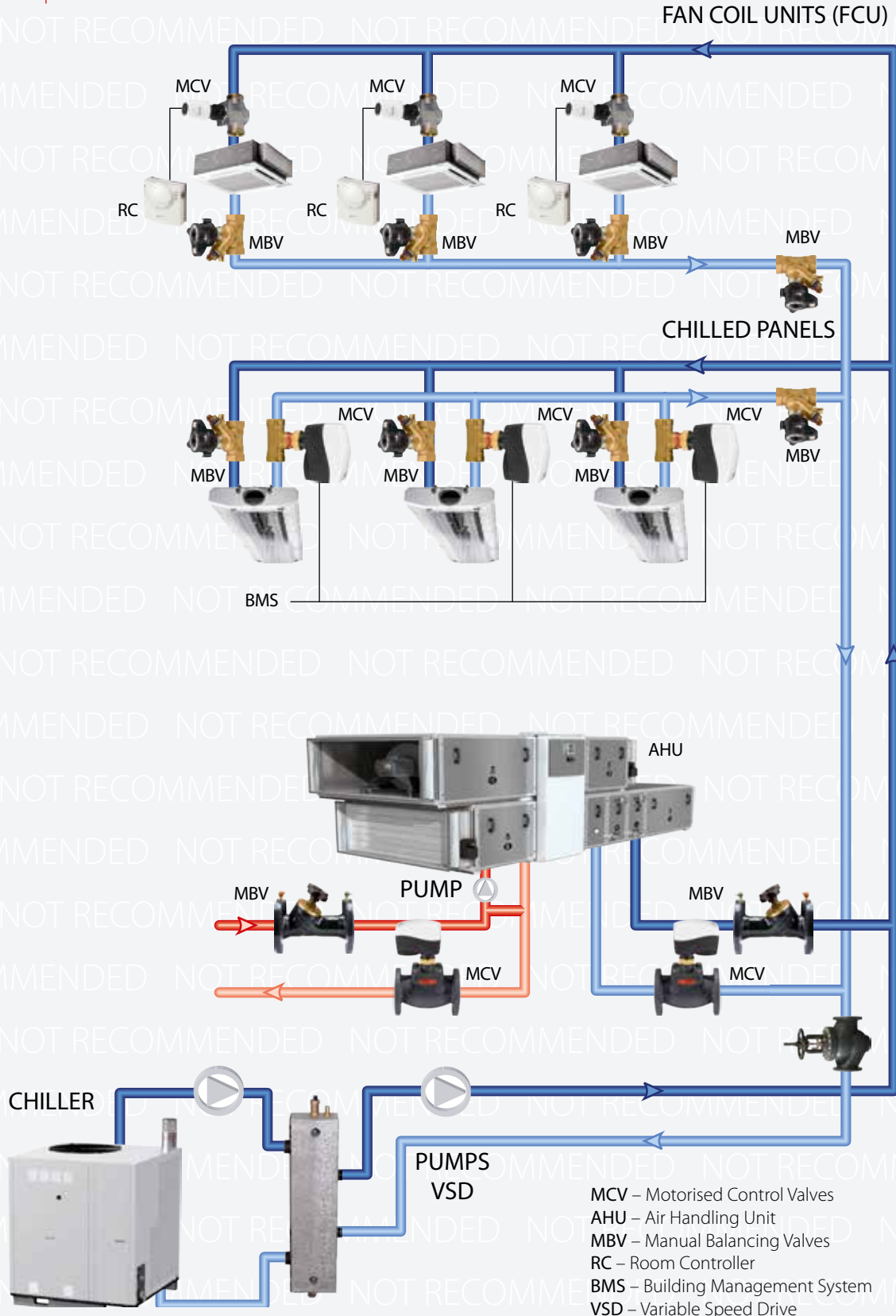

*Not Recommended – Not correct engineering, operating problems, not efficient

1 Design / Sizing

- **TRADITIONAL CALCULATION^{A)} REQUIRED FOR TRV OR MCV:**
- Kvs and authority of the valve
- Need complex hydraulic modelling
- Presetting calculation for terminal units and partner valves^{N)} are required
- Pump head calculation according to nominal flow

2 Operational cost

- **HIGH** pumping costs^{F)} (overflow and underflow problems)
- Heat losses and heat gains on the pipeline are medium
- Higher pump head demand – higher pressure loss on control valve to achieve good authority and extra pressure loss on partner valves for measurement is required
- Optimization of pump^{J)} head not possible unless if partners valves are implemented (MBV) + use compensation commissioning method^{D)}
- Good authority and high efficiency cannot be achieved^{K)}
- Re-commissioning is required from time to time^{C)}
- High room temperature oscillation

3 Investment

- Investment cost^{I)} – **MEDIUM** (“cheap” 2 port valve + MBV for commissioning)
- Expensive big dimension partner valves are required (mostly flange version)
- More valves – higher installation^{L)} costs (especially with extra flanges for bigger valves!)
- Commissioning of the system required^{B)}
- Variable speed pump^{S)} is recommended (constant pressure characteristic)

4 Designed ready for installation

- Hydraulic regulation all around in the system (terminal units and partner valves^{N)})
- Balancing at full load is OK but in partial load – **UNACCEPTABLE**
- Commissioning is very important but valid only in case of full load
- In case of TRV the Xp, the band is too high during partial load operation, bad room temperature control

5 Other

- Closing pressure of zone valves should be equal with pump head at nominal flow
- Significant overflow during partial load condition (manual balancing within the loop)
- Usually pump oversized and overloaded to achieve normal authority on MCV



NOT RECOMMENDED*

Application

2.2.2

Variable flow system, often used in radiator heating, FCU heating/cooling systems and in AHU – version with flow limiters and MCV

(In this application ensure variable flow in the distribution pipeline but we cannot ensure constant differential pressure on the terminal units and on the control valves. The flow is limited with PIBVs but in case of 3-point or modulation control, it is working against MCV.)

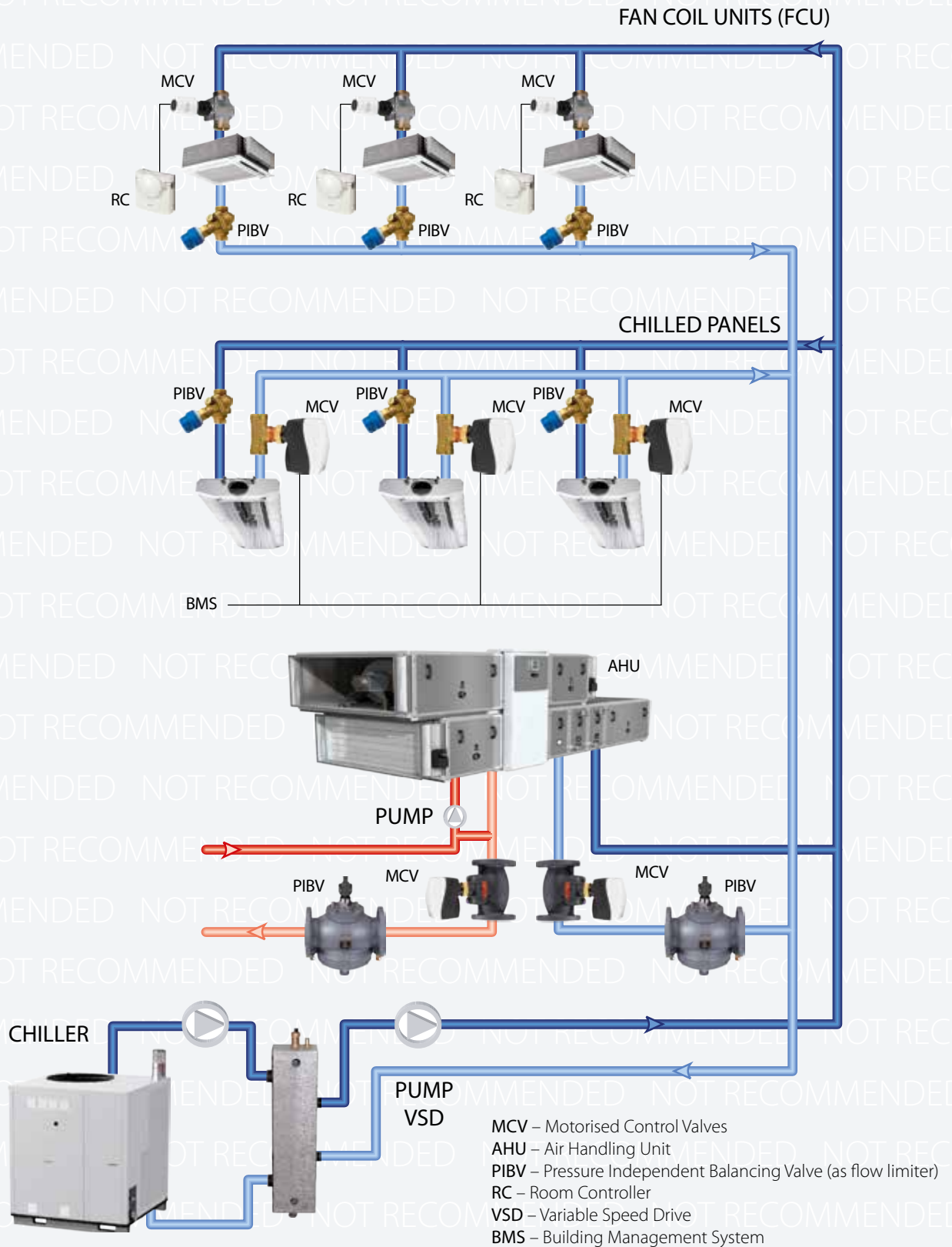

*Not Recommended – Not correct engineering, operating problems, not efficient

1

Design / Sizing

- **TRADITIONAL CALCULATION^{A)} REQUIRED FOR MCV :**
- Kvs and authority of the valve
- Simplified hydraulic calculation with flow limiter (no presetting needed, only the setting of flow)
- Pump head calculation according to nominal flow

2

Operational cost

- **LOWER** pumping costs – the max. flow is limited on the terminal unit
- Heat losses and heat gains on the pipeline are lower
- Higher pump head demand – higher pressure loss on control valve to achieve good authority and extra pressure loss on PIBV is required
- Optimization of pump head¹⁾ is possible if PIBV is equipped with measuring nipple
- In case of 3-point or modulation control, the MCV and PIBV work against each other, flow control is difficult. MCV has to come into operation very often, the life time of the MCV is shorter

3

Investment

- Investment cost¹⁾ – **VERY HIGH** (2 valves for all terminal unit)
- “Expensive” PIBV for each terminal unit
- Two times more valves – higher installation costs¹⁾
- Pump optimization in the system is recommended
- Variable speed pump⁵⁾ is recommended (constant pressure characteristic)

4

Designed ready for installation

- Hydraulic regulation all around in the system (terminal units and partner valves^{N)})
- Balancing at full load OK and in case only of ON/OFF control
- In case of 3-point or modulation control the balancing is – **UNACCEPTABLE** (in partial load)
- Presetting of PIBV is important

5

Other

- Closing pressure of zone valves should be equal with pump head at nominal flow
- **OVERFLOW** during partial load condition in case of 3-point or modulation, the controller compensates this continuously.
THE SYSTEM OSCILLATES EASILY.
- Usually pump is oversized

** where outdoor temperature can go below zero degree and cooling media (glycol) does not used



NOT RECOMMENDED*

Application

2.2.3

Variable flow two pipe heating/cooling system, typical application in FCU systems and any kind of terminal units (e.g. surface heating/cooling)

(In this application it is not possible to fulfil the heating and cooling system at the same time. In the heating/cooling centre we have to switch over to the zone valves according to the overall demand in the building. We ensure variable flow in the distribution pipeline and we ensure flow limitation to the bigger flow demand (typically at cooling) or flow control in both heating/cooling periods in the entire terminal unit independently from pressure oscillation in the system.)

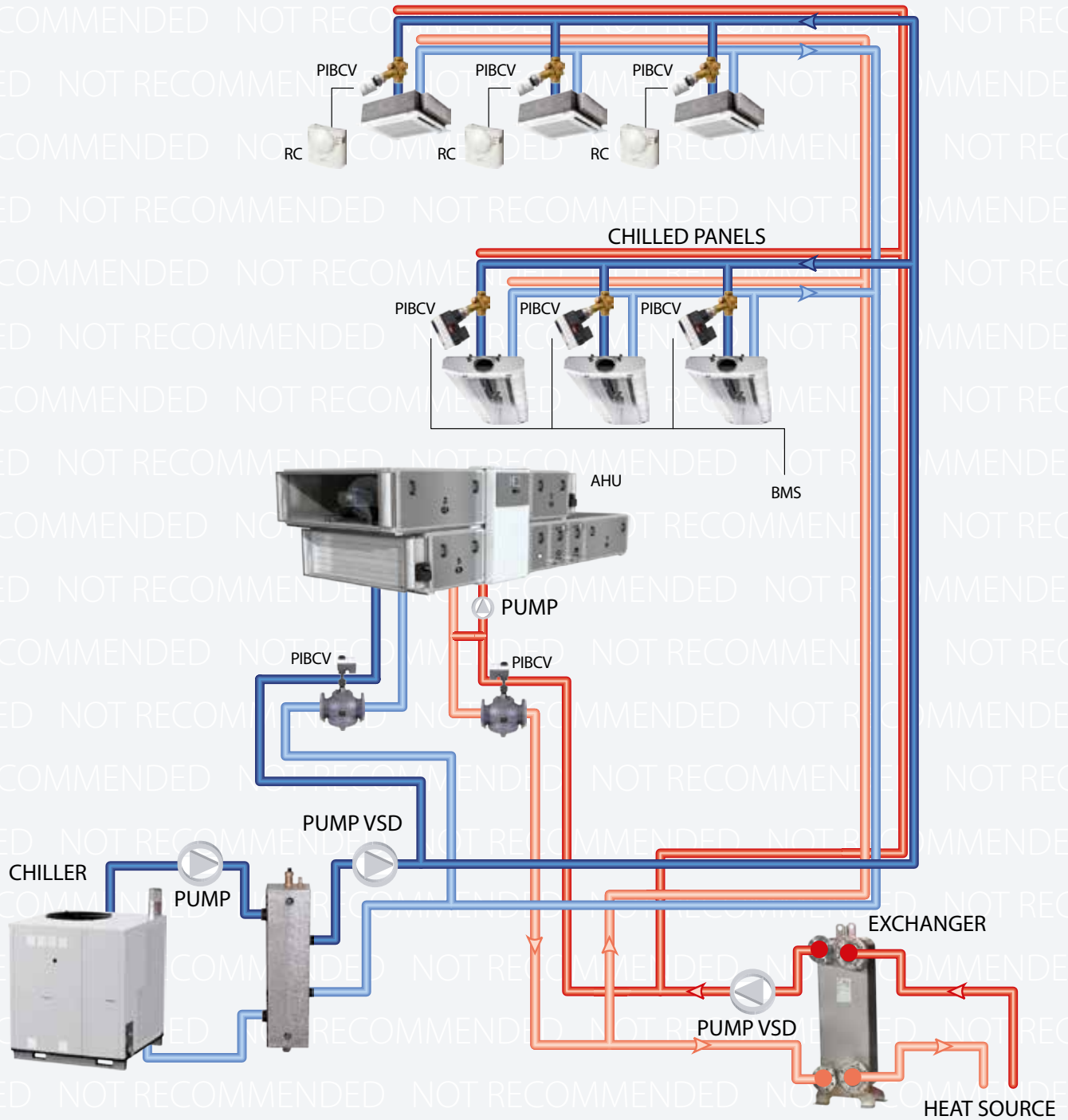

- PIBVC – Pressure Independent Balancing Control Valve
- AHU – Air Handling Unit
- RC – Room Controller for Heating and Cooling
- BMS – Building Management System
- VSD – Variable Speed Drive

*Not Recommended – correct engineering, operating problems, not efficient

1

Design / Sizing

- **SIMPLE CALCULATION METHOD**: no Kvs, authority or hydraulic presetting calculation
- Simple flow setting calculation according to bigger flow demand (heating or cooling)
- Sizing of pipeline according to bigger flow demand (generally cooling)
- Pump head calculation according to min. Δp on the control valve and system pressure loss at nominal (bigger – cooling) flow. /Lower pump head is possible in case of lower flow demand (heating) if flow limitation is solved at terminal unit in a certain way./
- Practical to come near the difference temperature in heating and cooling systems

2

Operational cost

- **LOWEST** pumping costs^{F)} both in heating and cooling, energy saving with VSD
- Does not run heating and cooling at the same time
- Heat losses and heat gains on the pipeline are minimum (only two pipelines)
- Lowest pump head demand (mainly in heating because of lower flow in bigger pipeline)
- Optimization of pump head^{J)} is recommended, re-commissioning^{G)} of the system is not required
- Control valves – 100% authority and best efficiency, minimum room temperature oscillation^{K)}

3

Investment

- Investment cost^{I)} – **LOW** – (only 2 pipelines, 1 PIBCV for simple –two pipe – terminal units)
- Zone valves required in change over unit
- No hydraulic element in the system anymore
- Commissioning of the system not required^{B)}
- Variable speed^{S)} pump is recommended

4

Designed ready for installation

- Is **NOT POSSIBLE TO HEAT AND TO COOL AT THE SAME TIME**, fulfil the "A" classification^{X)} requirement
- Balancing is **EXCELLENT** at full and partial load in case of bigger flow demand (cooling)
- Flow deviation is problematic in case of lower flow demand, overflow is possible
- Difficult to determine the change over time (winter/summer)

5

Other

- PIBCV is able to close against 6 bar
- **ENSURE EXACT FLOW LIMITATION**, different flow demand in heating and cooling is possible **WITH SPECIAL ROOM THERMOSTAT OR BMS SYSTEM**
- Minimal total energy consumption, **MAXIMUM ENERGY SAVING^{T)}**



NOT RECOMMENDED*

Application

2.2.4

Constant flow system with manual balancing in Domestic Hot Water circulation network

(In this application we ensure constant flow in the domestic hot water circulation pipeline independently from temporary hot water usage and demand.)



MBV – Manual Balancing Valve

*Not Recommended – Not correct engineering, operating problems, not efficient

1

Design / Sizing

- **TRADITIONAL CALCULATION^{A)}**: Kvs of the manual balancing valve
- Complicated circulation flow demand calculation according to heat loss on global hot water and circulation pipeline
- Pump head calculation according to nominal flow

2

Operational cost

- **HIGH** pumping costs^{F)} – constant speed pump
- Large **HEAT LOSSES** on the circulation pipeline
- Optimization of pump^{J)} not possible
- Re-commissioning^{G)} of the system is required from time to time
- Lower efficiency of boiler or substation due to high return temperature

3

Investment

- Investment cost^{I)} – **LOW** (cheap MBVs, constant speed pump)
- Higher installation cost^{I)} – partner valves^{N)} are required
- **COMMISSIONING** of the system is required^{B)}
- No Variable Speed Drive demand

4

Designed ready for installation

- Variable tapping temperature^{Z)} (depends on distance from DHW^{M)} tank)
- Balancing at full and partial load – **ACCEPTABLE**
- Variable speed pump not recommended, huge temperature losses on pipeline – **NO** energy saving^{T)}

5

Other

- **HIGH OVERFLOW**, the circulated flow is constant and independent from demand
- Fair cost accounting not possible due to different tapping temperatures
- Usually pump is oversized
- Thermal disinfection^{Q)} of the system is expensive



2.3.1

Variable flow system, application in two pipe radiator heating systems with thermostatic radiator valve and flow limiter

(In this application we ensure variable flow in the distribution pipeline with TRV'S. Usage of flow limiter – as balancing valve – causes hydraulic problems. The flow limiter keeps a constant flow on the riser thus works against the thermostatic radiator valves. (Flow limiter is continuously open while the TRV's are closed.)

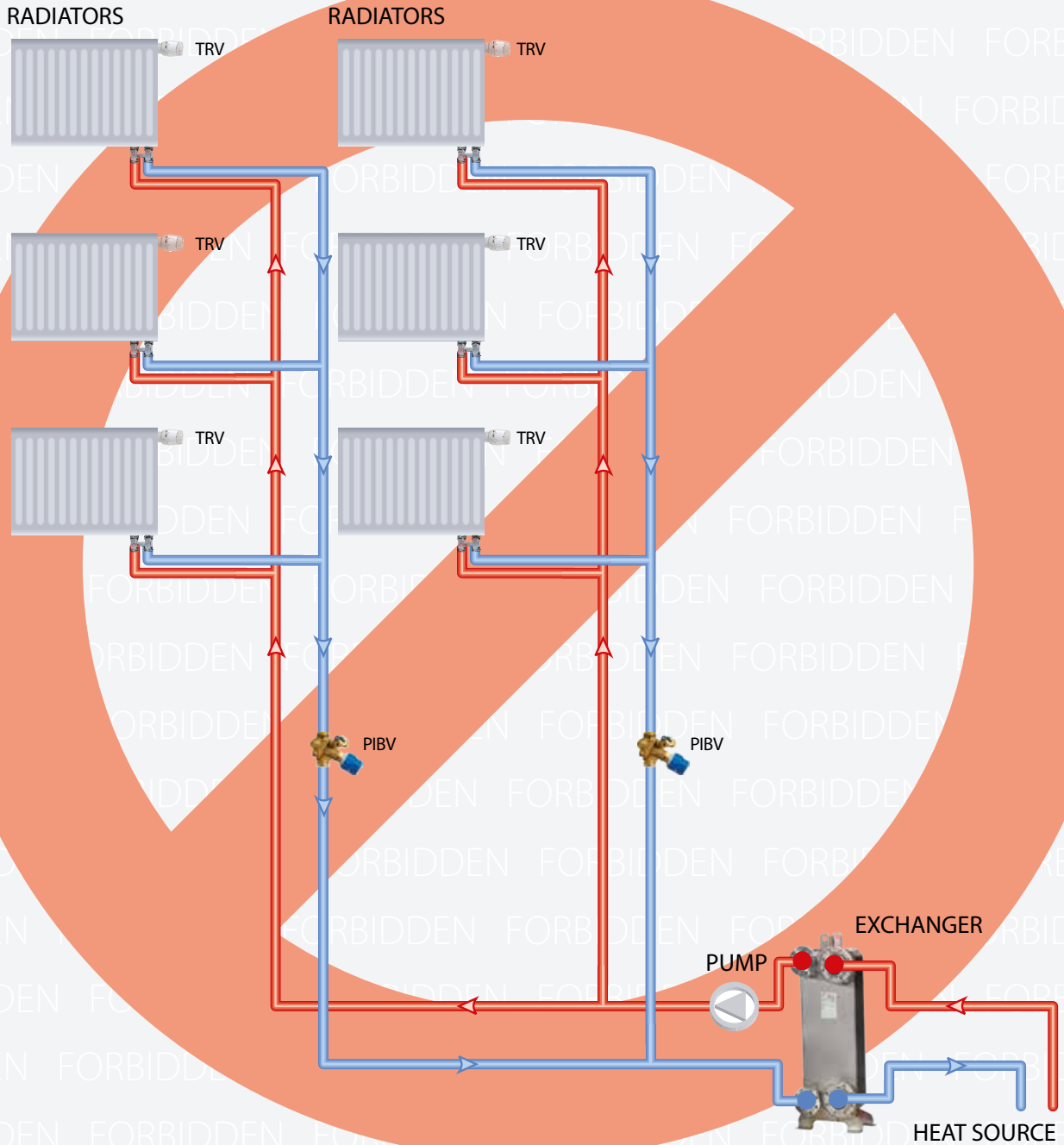

TRV – Thermostatic Control Valves

PIBV – Pressure Independent Balancing Valves (as flow limiter)

*Forbidden – do not ever use!!!

1

Design / Sizing

- **TRADITIONAL CALCULATION^{A)} REQUIRED FOR TRV:** Kv and authority of the value
- Presetting calculation of TRVs according to complex hydraulic modelling
- Flow limiter presetting is equal to the required flow
- Pump head calculation according to nominal flow

2

Operational cost

- **HIGH** pumping costs ^{F) 3.2}
- TRV works with low authority (flow limiter is open while the TRVs are closed) – generally as ON/OFF control – high room temperature oscillation ^{K)}
- Heat losses on the pipeline are medium – overflow on the system
- High pump head demand – needed high Δp , flow limiter is open while the TRVs are closed, high ΔP required due to valve authority
- Optimization of pump head is possible (in case of measuring nipple on flow limiter)

3

Investment

- Investment cost ^{l)} – **EXPENSIVE** – Mainly, unless the control capacity of TRV is taken into consideration. Expensive flow limiter destroys the control level

4

Designed ready for installation

- The flow limiter takes effect **ONLY** case of nominal flow
- Hydraulic regulation in part load operation is **NOT ACCEPTABLE**, the flow limiter works against TRVs (flow limiter is open while the TRVs are closed)
- Balancing at partial load – **BAD** – wrong comfort
- Relatively high room temperature oscillation (as ON/OFF control)

5

Other

- Closing pressure of TRVs should be equal with pump head at zero flow ^{l)}
- Overflow during partial load condition (self acting control is not able to compensate it)

3

Glossary and abbreviations of 2.1, 2.2 and 2.3

- A** | **Traditional calculation:** For good control, we have to take the two most important control features into consideration; the authority of the control valve and the pressure equivalence in front of each terminal unit. For this requirement we have to calculate the required kvs value of the control valves and treat the whole hydraulic system like one unit.
- B** | **Commissioning:** However we have to calculate the required settings of the manual or automatic balancing valve during the traditional calculation, before we hand the building over to the user. We have to be sure that the flow is according to the required value all over. For that, (due to installation imprecision), we have to check the flow on the measuring points and correct this if necessary.
- C** | **Re-commissioning:** From time to time commissioning must be redone. (E.g. in the case of changing the function and size of the room, regulating heat loss and heat gain).
- D** | **Compensating commissioning method:** Special commissioning procedure for when a partner valve is used to compensate the effect of fluctuations in the manual balancing valve (for more details please contact Danfoss).
- E** | **Good authority:** The authority is a differential pressure rate which slows the pressure loss of the control valve and is compared to the available differential pressure $a = \frac{\Delta p_{MCV}}{\Delta p_{MCV} + \Delta p_{pipes/units}}$. The authority is good if the value has a minimum of 0,5-0,6.
- F** | **Pumping cost:** The expense that we have to pay for pump energy consumption.
- G** | **Constant flow:** The flow in the system or the unit does not change during the whole operational term.
- H** | **Low ΔT syndrome:** This is more significant for cooling systems. If the required ΔT in the system cannot be ensured, the efficiency of the cooling machine declines dramatically. This symptom can also occur in heating systems.
- I** | **Investment (installation) cost:** the whole amount what we have to pay for a certain part of installation (in case of comparison we have to take into consideration whole cost of implementation including installation and other accessories).
- J** | **Pump optimization:** In the case of electronic controlled pump usage, the pump head can be reduced to the point where the required flow in the whole system is still ensured, bringing the energy consumption to a minimum.

- K** | **Room temperature oscillation:** The real room temperature deviates constantly from the set temperature all the time. The oscillation means the size of this deviation.
- L** | **No overflow:** The constant flow through a terminal unit according to the desired flow, no overflow.
- M** | **DHW:** Domestic Hot Water system.
- N** | **Partner valve:** An additional manual balancing valve is required for all branches to achieve commissioning properly.
- O** | **Variable flow:** The flow in the system varies continuously according to temporarily partial load. It is dependent on external circumstances like sunshine, internal heat gains, room occupation, etc.
- P** | **Missing by-pass:** In the case of a FCU application with 3 or 4 ports valve, the MBV is missing from the by-pass branch. In this way it is not possible to equalize the pressure loss in the FCU and in the by-pass branch. The flow will not be same.
- Q** | **Thermal disinfection:** In DHW systems the number of Legionella bacteria increases dramatically around tapping temperature. It causes diseases and from time to time it can lead to death. To avoid this, disinfection is needed periodically. The simplest way to do this is to increase the temperature of the DHW above ~60-65 °C. In this temperature the bacteria will be destroyed.
- R** | **EPBD:** Energy Performance of Building Directive – according to 2002/91/EK recommendation, obligatory in the EU from 02 January, 2006. This regulation taking deals with energy saving and system revisions.
- S** | **Variable speed drive (VSD):** Circulation pump is equipped with built in or external electronic controller, ensuring constant, proportional (or parallel) differential pressure in the system.
- T** | **Energy saving:** Electrical and /or heat cost reduction.
- V** | **Group:** 2-4 pcs. terminal units controlled by one temperature signal.
- W** | **Change over:** In those systems where cooling and heating do not function parallel, the system must be changed between these operational modes.
- X** | **“A” classification:** The rooms are classified according to comfort capability (EU norm). “A” means the highest rank with smallest room temperature oscillation and better comfort.
- Y** | **Stable room temperature:** Achievable with proportional self acting or electronic controller. This application avoids room temperature due to oscillation because of hysteresis of on/off room thermostat.
- Z** | **Tapping temperature:** The temperature that immediately appears when the tap is opened.

3.0

Valve authority

3.0.1 Definition

The authority of the valve is a measure of how well the control valve (CV) can impose its characteristic on the circuit it is controlling. The higher the resistance in the valve, and therefore the pressure drop across the valve, the better the control valve will be able to control the energy emission of the circuit.

The authority (a_{cv}) is usually expressed as the relationship between the differential pressure across the control valve at 100% load and fully open valve (the minimum value ΔP_{min}), and the differential pressure across the control valves when it is fully closed (ΔP_{max}). When the valve is closed, the pressure drops in other parts of the system (pipes, chillers and boilers for example) disappear and the total available differential pressure is applied to control valves. That is the maximum value (ΔP_{max}).

Formula: $a_{cv} = \Delta P_{min} / \Delta P_{max}$

The pressure drops across installation are illustrate in Fig 3.1.

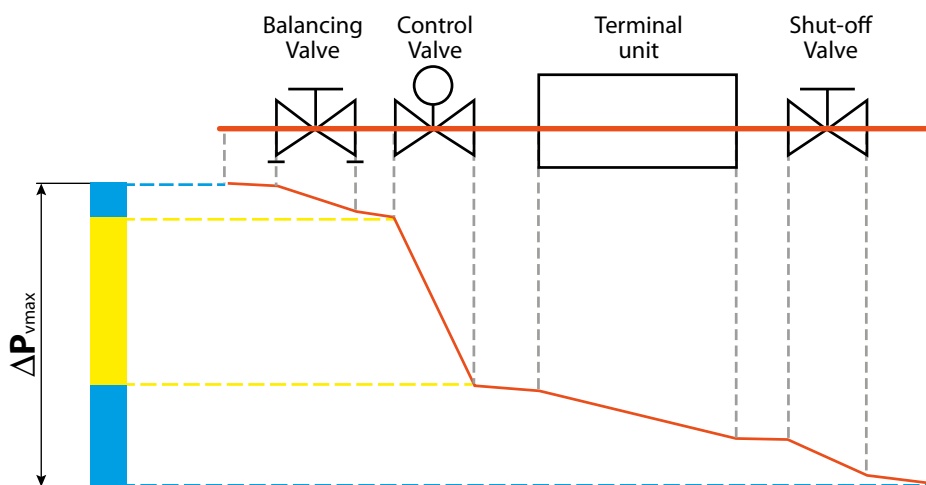

Fig 3.1

3.0.2 Valve characteristics

Each control valve has its own characteristic, defined by the relation between the lift (stroke) of the valve and the corresponding water flow. This characteristic is defined at a constant differential pressure across the valve, so with an authority of 100% (see formula). During practical application in an installation, the differential pressure is however not constant which means that the effective characteristic of the control valve changes. The lower the authority of the valve, the more the characteristic of the valve is distorted. During the design process we have to ensure the authority of the control valve is as high as possible to minimise deformation of the characteristic.

The most common characteristics are presented below in the graphs:

1. Equal percentage/Logarithmic control valve characteristic (fig 3.2a)
2. Linear control valve characteristic (fig 3.2b)

The line designated with 1.0 is the characteristic at an authority of 1 and the other lines represent progressively smaller authorities.

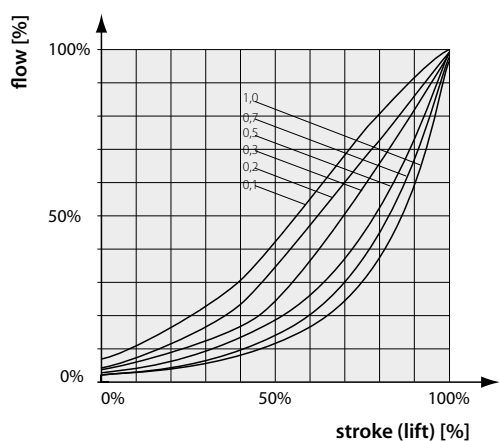

Fig 3.2a

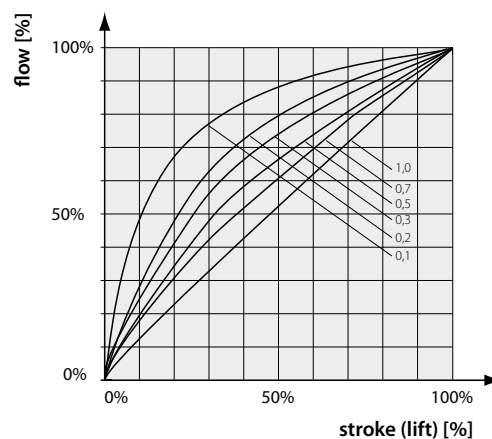

Fig 3.2b

3.0.3 Control

Processes are easiest to control when the relationship between the signal and the output is linear. Ideally, an increase in the control signal of 10% should result in an increase of the output by 10%. With modulating climate control processes (0-10 Volt) that means that an increase of the control signal of 1 Volt (10%) should increase the output of the terminal unit (i.e. fancoil unit, radiator, AHU) by 10%.

Water to air heat exchangers, such as those that are found in FCUs, radiators and AHUs, do not have a linear emission curve (flow-output) but are usually similar to Fig 3.3a

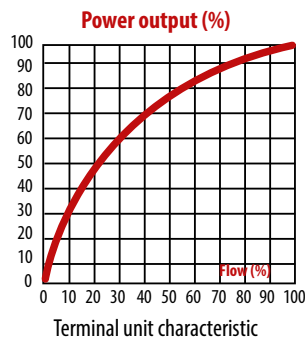

Fig3.3a

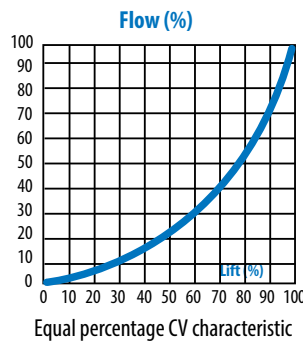

Fig 3.3b

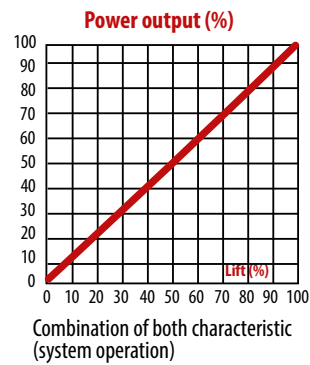

Fig 3.3c

Therefore, to get the ideal linear output you need to have a control valve that compensates for that curve in the output. That is why the equal-percentage valve curve (fig3.3b) is counter to the terminal unit characteristic. If you take the resultant of both curves together it should give you the desired linear output, as in Fig 3.3c

However, as stated above, the valve characteristics are defined at an authority of 1, which is not a realistic scenario in a practical situation. So, let's take an improperly sized linear valve with an authority of 0.1. If the valve is opened 20%, the flow through the valve is more than 50% (see Fig 3.2b). Combine that with the terminal unit characteristic in Fig 3.3a and you can see that at a flow of 50% the output of the terminal unit is already 80%. So, a valve lift (opening) of 20%, results in an output of 80%! Effectively that means that instead of a stable and comfortable, modulated room temperature control, we get a wildly fluctuating control that will operate as On/Off and will result in uncomfortable, fluctuating room temperatures (Fig 3.4b)

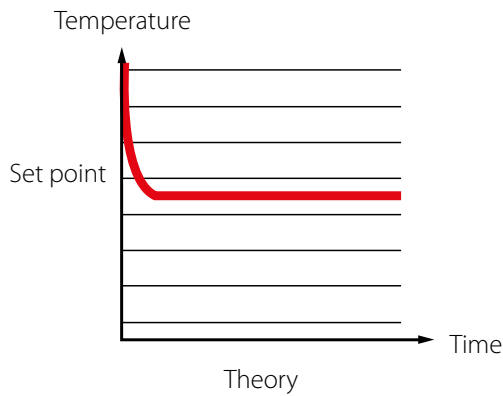

Fig 3.4a

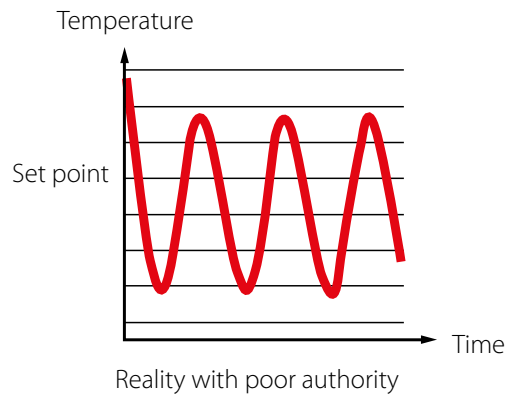

Fig 3.4b

3.0.4 Conclusion

Because every cooling and heating system contains terminal units like fancoils or radiators that are controlled by control valves, we always have to consider the combination terminal unit-control valve. The objective is to make the output of both components close to linear because in that case the emission becomes proportional to the signal of the controller. This makes the control loop stability almost independent of the load.

The better the authority of the control valve is, the more the flow is controlled according to the control characteristic. One of the requirements that is often used in connection with the choice of control valves is to size them with an authority of 0,5 or higher. That means that the pressure drop across the fully open valve has to be at least equal to the pressure drop in the terminal unit, pipes and accessories of the circuit. This will ensure a reasonable quality of control.

A new generation of control valves (PIBCV), as presented for example in chapter 2.1.1, ensures 100% authority, independent of the load or the system design. This ensures perfect temperature control and low operational costs. Because of the automatic full authority they are easy and simple to size without complicated kv and Authority calculations and are therfor cost-saving compared to PIBCVs.

3.1

The “low ΔT syndrome”

Chillers are sized for certain extreme conditions which depend on the climate relevant for that installation. It is important to realize that, in general, that means that the chillers are oversized since these extreme circumstances occur during less than 1% of the operational time. Effectively we can say that the installation is running in partial load for 99% of the time. When the installation is running in partial load we can experience a phenomenon Low ΔT syndrome which can cause very low chiller efficiencies and fast on-off switching of the chiller. Additionally the low ΔT syndrome prevents the chillers from running in the so-called Max-Cap mode. During Max-Cap the chiller can put out more than its rated capacity at very high efficiencies.

Low DT syndrome occurs when the return supply temperature to the chiller is lower than designed. If the installation is designed for a differential temperature of 6 K but the water fed into the chiller is only 3 K lower than the chilled water supply setpoint, it is easy to understand the chiller can supply maximally only 50% of its rated capacity. If that is insufficient for the situation either the installation will not have enough capacity or an extra chiller needs to be brought online.

Take this example: when the secondary circuit return water temperature is lower than design temperature (due to overflow problems etc.), chillers cannot be loaded at their maximum capacity. If the chillers in the chilled water plant, designed to cool 13°C chilled water return to 7°C, are receiving a design flow rate at 11°C rather than a design temperature of 13°C, the chiller will be loaded at the ratio of:

$$\text{CHL}(\%) = \left[\frac{\text{CWRTR} - \text{CWSTD}}{\text{CWRTD} - \text{CWSTD}} \right] \times 100\% = \left[\frac{11-7}{13-7} \right] \times 100\% = 66,6\%$$

Where:

CHL (%) – Percent chiller loading

CWRTR – Real chilled water return temperature (in our case , 11°C)

CWSTD – Design chilled water supply temperature (in our case, 7°C)

CWRTD – Design chilled water return temperature (in our case, 13°C)

In this case, where the low ΔT in the plant (the difference between return and supply chilled water temperature) has been lowered from 6°C (13°C-7°C) design condition to 4°C (11°C-7°C) , the capacity of the chiller has been reduced with 33,4 %.

In many cases the operating efficiency of the chiller can drop 30 to 40 percent when the return chilled water temperature is lower than the design. Contrarily when the DT is increased, the efficiency of the chiller can increase up to 40%.

There are several potential causes of low ΔT syndrome:

- Using three-way control valves:

Three-way valves by their nature bypass the supply chilled water into the return line during part load conditions, causing the chilled water temperature to be lower than design. This exacerbates low ΔT problem (presented in application 2.1.4).

The remedy: Do not use three-way control valves but use a variable flow system with modulating control. If 3-way control valves are unavoidable, application 2.1.3 is recommended to limit overflows in part load conditions.

- Poor 2-way control valve selection with improper system balance:
An improperly sized two-way control valve may allow a higher water flow than necessary. The low ΔT syndrome is worse in partial load due to pressure changes in the system, which results in a high overflow through the control valves. This phenomenon occurs in particular in systems with faulty hydraulic balance as presented in application 2.2.1. The remedy: 2-way control valves with built in pressure controllers. The pressure control function on the control valves eliminates the overflow problem and therefore eliminates low ΔT syndrome.
- Others such as:
Improper set-point, control calibration or reduced coil effectiveness.

3.2 The “overflow phenomenon”

One of the sources of the well known problems in chilled water systems such as low ΔT syndrome is the overflow phenomenon. In this chapter, we will shortly try to explain what it is and what causes it.

All systems are designed for nominal conditions (100% load). Designers calculate pump heads based on the combined pressure drop in pipes, terminal units, balancing valves, control valves and other elements in the installation (strainers, water meters etc), assuming the installation is operating at maximum capacity.

Consider a traditional system as presented below, fig. 1a, based on application 2.2.1. It is obvious that the coil and control valve located closer to the pump will have a higher available pressure as compared to the one last in the installation. In this application, unnecessary pressure has to be reduced by manual balancing valves, so the manual balancing valves closer to the pump will be more throttled. The system operates properly only with 100% load.

In fig. 1b we see a so-called reverse return system. The idea behind this system is that because the total pipe length for every terminal unit is equal, no balancing is necessary because the available pressure for all units is the same. Please note that if the terminal units require different flows you still need to balance the system with balancing valves. In general we can say that the only proper application of a reverse return system is when we’re talking about a constant flow system (3-way valves) and when all the terminal units are of the same size.

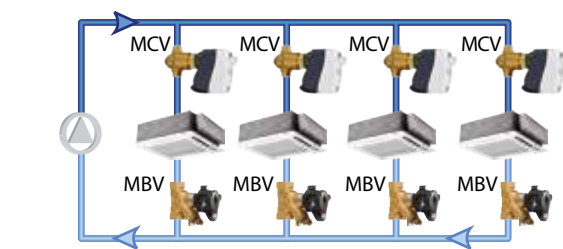

Fig. 1a
Direct return system (not recommended system)

$$\Delta P_4 = \Delta P_{\text{critical}}$$

$$\Delta P_1 > \Delta P_2 > \Delta P_3 > \Delta P_4$$

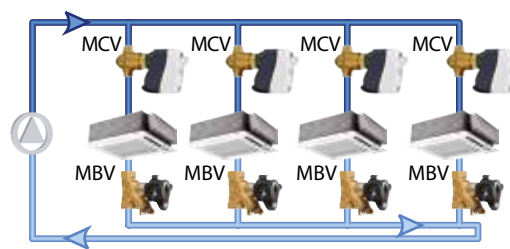

Fig. 1b
Variable flow **static** FCU control

$$Q_1 \neq Q_2 \neq Q_3 \neq Q_4 \quad \Delta P_4 = \Delta P_{\text{critical}}$$

$$\Delta P_1 = \Delta P_2 = \Delta P_3 = \Delta P_4 = \Delta P_{\text{critical}}$$

To control flow across each coil, two-way control valves are used. Consider the situation in partial load (i.e. coils 2 and 3 are closed).

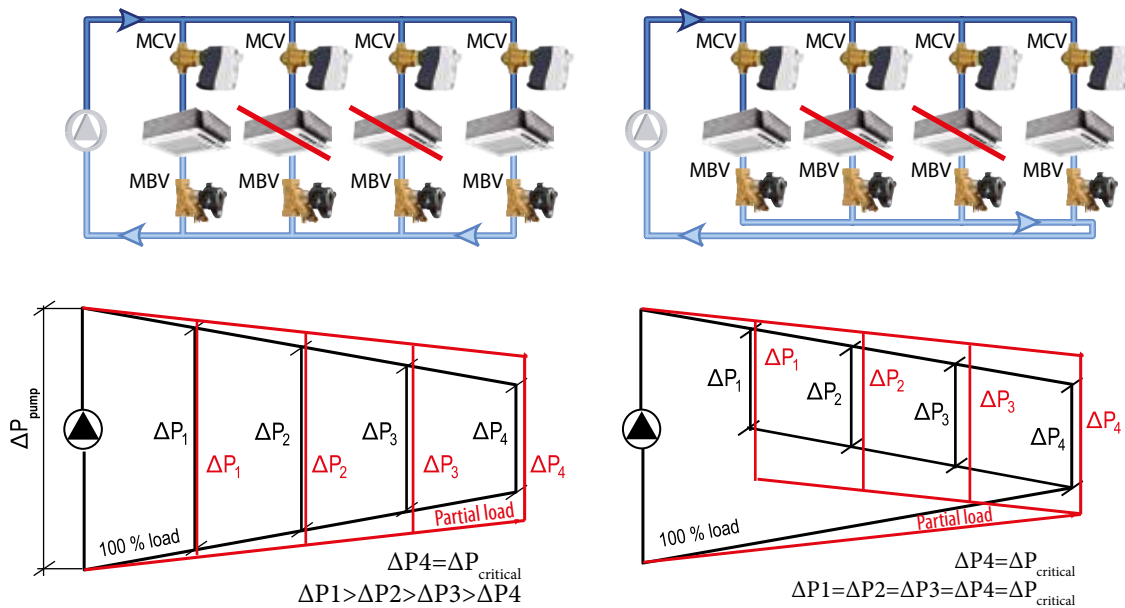

Fig. 2a
Partial load – direct return system

Fig. 2b
Variable flow **static** FCU control

Due to a lower flow in the system, the pressure drop in the pipe system decreases, providing a higher available pressure in the still open circuits. Since manual balancing valves (MBV) with fixed, static, settings were used to balance the system, the system becomes unbalanced. Consequentially a higher differential pressure across the 2-way control valves causes overflows across the coils. This phenomenon appears in direct return systems as well in reverse return systems. This is the reason why these applications are not recommended, as the circuits are pressure dependent.

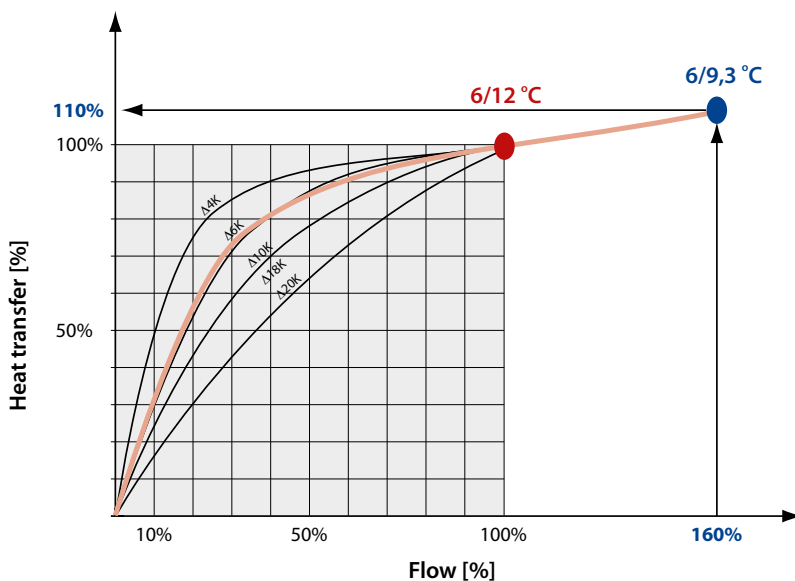

Fig. 3
Terminal unit emission characteristic

The traditional FCU is usually designed for a DT of 6 K. The 100% emission is achieved at 100% flow across the unit at a supply temperature of 6°C and a return 12°C. The overflow across the unit has little influence on the emission. However another phenomenon is more critical for proper chilled water system functionality. Higher flow across the units has an incredible influence on heat/cool transfer which means

that the return temperature never achieves the design temperature. Instead of the design temperature of 12°C, the real temperature is much lower, for example 9,3°C. The consequence of a lower return temperature from the FCU can be low DT syndrome.

For variable flow systems it is not recommended to use fixed speed pumps as they worsen the overflow problem. In fig. 4 this can be seen clearly. The figure represents the pump curve and the differently colored areas represent the pressure drops in the system. The red area represents the pressure drop across the control valve. If we let the pump follow its natural curve we see that with a decreasing flow, the differential pressure will rise. If you compare the differential pressure at 50% of the load you can see that the available pump head is much higher (P_1) than the pump head at full load (P_{nom}). All the extra pressure will have to be absorbed by the control valve. This will cause overflows in the system, as well as a serious deformations of the characteristic of the valve.

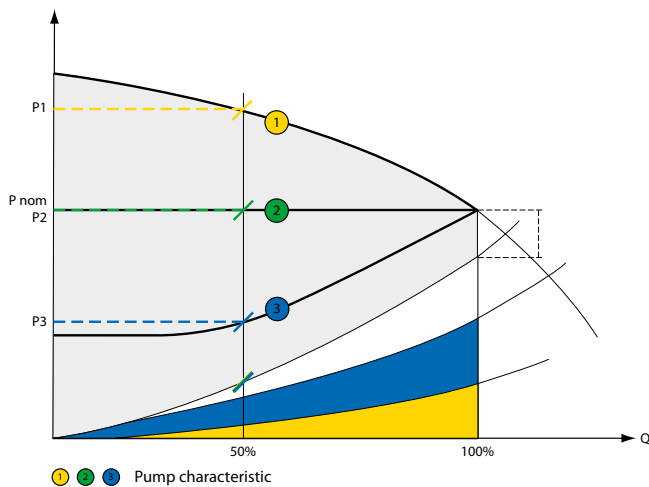

Fig. 4
Different pump characteristics

Today the commonly used Variable Speed Drives (VSD) with pressure transmitters can modify the pump characteristic in accordance with flow and pressure changes in the water system. The nominal flow at 100% load and the above mentioned pressure drop in the system determine the pump head which is equal to the nominal pressure, P_{nom} . We can see that a constant differential pressure results in a much better situation at partial load, the differential pressure across the control valve will increase much less than when the natural curve of the pump is followed. Please note however that the pressure across the control valve will still rise considerably.

Some modern pumps come equipped with speed controllers that can modify the pump not only based on the pressure but also on the flow, the so-called proportional control. If the flow is reduced, also the differential pressure is reduced. Theoretically this gives the best results as can be seen at P3 in fig. 4. Unfortunately it is unpredictable where in the installation the flow will be reduced so there is no guarantee that the pressure can be reduced as much as can be seen in Fig. 4. It is therefore strongly recommended to limit the difference between P2 and P3 to prevent parts of the installation from starving in certain situations.

The inescapable conclusion is that over- and underflow problems can not be solved by the pump alone. It is therefore strongly recommended to use pressure independent solutions. Pressure independent Balancing and Control Valves (AB-QM) can take care of pressure fluctuations in the system and will provide the terminal units always with the right flow, under all loads of the system. We definitely recommend using VSDs on the pump since that will result in very big savings. As for the control method we recommend to use fixed differential pressure control which will guarantee enough pressure under all circumstances. If proportional control is wanted than the AB-QM can operate under such conditions but we recommend keeping the difference between P2 and P3 to a minimum to prevent starving of certain parts of the installation during partial load.

3.3 The “underflow phenomenon”

As can be seen from Fig. 1a, the available pressure for the first circuit is much higher than the pressure for the last circuit. In this application the MBVs should take care of this by throttling the excess flow. So, the last MBV should be opened as much as possible and the other MBVs should be more and more throttled the closer they are to the pump.

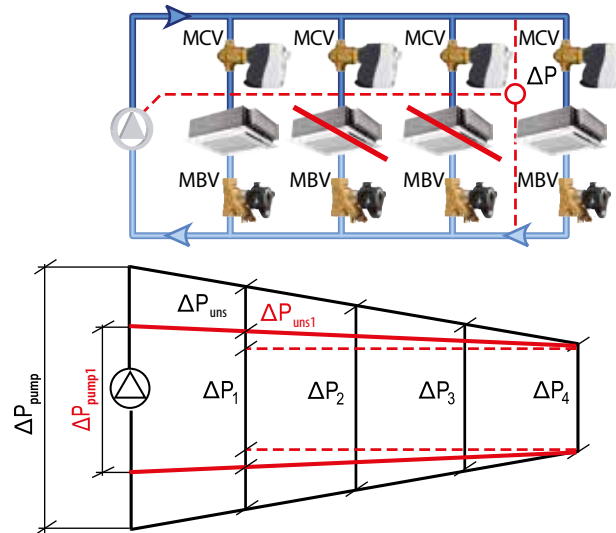

Fig. 5
Direct return system with proportional

A very standard application places the differential pressure sensor controlling the pump at the last terminal unit to minimize pump consumption. We can see what happens when the two middle terminal units are closed. Because the flow in the piping is considerably reduced also the resistance in the system goes down which means that most of the pump head ends up at the end of the installation where the sensor is. This is represented by the red lines in Fig. 5. If you look at the first unit you can see that, even though the pressure for the loop should be the same, it actually gets a much lower differential pressure and therefore too little flow. This can lead to the confusing situation where the installation is operating without problems on full load and when the load is reduced there are capacity problems close to the pump. Needless to say that putting the pump on proportional control will enhance the problems considerably. The pump senses a 50% drop in the flow and will drop the differential pressure accordingly, creating even lower flows in the first terminal unit and a capacity problem at the last terminal unit as well.

An often suggested compromise between creating underflows and minimizing the pump consumption is to put the sensor on a place two thirds of the system. This is however still a compromise and is no guarantee for having the right flow under all circumstances. An easy solution is to mount Pressure Independent Balancing and Control Valves (AB-QM) on every terminal unit and control the pump on constant differential pressure. That way you will maximize the savings on the pump without any under- or overflow problems.

4

Project case study: comparison of 2.1.1, 2.1.2 and 2.1.4 applications

4.1

Operational costs

Energy saving with dynamic 'balancing' in an office building

General overview:

In spite of ever increasing energy prices, new buildings are typically "optimised" on the basis of the investment costs only. In the near future this trend must be changed, the energy saving, the higher comfort demand (A, B, C building classification) will be more and more important.

In this material we present how much energy we can save with a new control method compared to the traditional solutions. For this we chose a real office building with the following parameter: total of 18 430 m² floor space on 15 levels. It has a four pipeline fan-coil (total of 941 units) system and ON/OFF room thermostat controlled by thermo-hydraulic motors. The examination only focuses on the FCU system.

Applicable control systems solutions that occur most frequently in practice are examined in detail.

1. Constant flow system with static balancing (see fig. 1 for schematic drawing).
2. Variable flow system with static balancing (see fig. 2 for schematic drawing).
3. Variable flow system with dynamic balancing (see fig. 3 for schematic drawing).

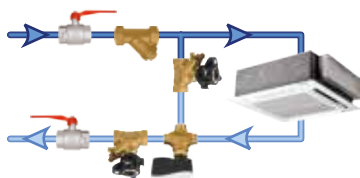

Fig. 1
Constant flow FCU control
(acc. application 2.1.4: acceptable)

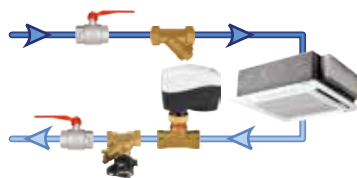

Fig. 2
Variable flow **static** FCU control
(acc. application 2.2.1: not recommended)

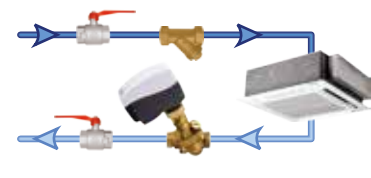

Fig. 3
Variable flow **dynamic** FCU control
(acc. application 2.1.1: recommended)

System modelling:

For energy saving calculation the system has to be modelled in PC hydraulic design program. We have examined what will happen in the system at 100% load in design condition, and at 50% of the yearly average load. The system was examined on the basis of 150 Pa/m specific resistance.

- In case of a constant flow system, it is sufficient to perform hydronic calculations at full load because flow rate does not change at partial loads. As system required manual commissioning where usually achieved accuracy is +/- 15 % we assume that pump will be adjusted for 15% higher capacity to cover shortage flow in the system.
- In case of static balancing, first sizing was performed based on nominal load and partial load meaning that 50 % of the consumers were randomly shut off. Results give us an average of 42% additional flow rate – due to increasing available differential pressure on the FCU unit – for the cooling system in half-load condition (this value corresponds to the seasonal average).
- In case of dynamic balancing, analysis was simple because the automatic controllers provide the same flow rates for consumers at partial load, as they do at full load and that is irrespective of pressure changes.

Possibility of energy saving:

Here questions arise where energy can be saved during operation. There are the following:

- 1.| Pump energy saving – with focus on overflow phenomena (included in case study)
- 2.| Heat losses from the pipeline – lower return temperature ensures less energy loss in pipeline
- 3.| Accurate room temperature control – reduce the oscillation of room temp., this saves energy
- 4.| Efficiency of heat generating efficiency – higher ΔT on the system ensures higher efficiency
- 5.| Saving with no numerical date – e.g. health issues, comfort, reclaim handling.

Energy saving in HVAC system is a very complex topic and all the above mentioned factors should be analyzed by energy auditors. For our purpose only the pumping cost will be considered with the product's investment cost.

4.1.1

Pumping energy saving

Case study is based on real project data, building specifications are presented below :

- 15 stories building with 10 risers , type of the building – office
- Total flow in the system 215 m³
- Pump head – 250 kPa
- Power pump – 20,1 kW :
 - application 1 – constant flow system, pump without regulation (with 15% surplus due to manual commissioning)
 - application 2 – variable flow system, pump with constant pressure characteristic (with 15% surplus due to manual commissioning)
 - application 3 – variable flow system, pump with proportional pressure characteristic

- Number of fan-coil units (FCU) – 941 pcs
- Energy prices : 0,0835 Euro/kWh
- Ratio of rooms occupied (based on average date)
 - 100 % – 6% of total time of exploitation
 - 75% – 15 % of the time of exploitation
 - 50% – 35 % of the time of exploitation
 - 25% – 44% of the time of exploitation

Before explaining the calculations, let's discuss what kind of pump control can be used and where. There is no need for pump control in a constant flow system. For variable flow systems, companies prefer static elements for maintaining a constant differential pressure (to be on the safe side), while manufacturers recommend dynamic balancing for proportional control (in the interest of greater energy saving).

Now, let's have a look at the previously mentioned building. The cooling system has a Grundfos TPE 150-280/4-AS circulation pump selected for the purpose. Its operating point is 250 kPa at 215 m³/h flow (due to manual commissioning application 1 and 2 were calculate with 15% overflow it means 247 m³/h flow).

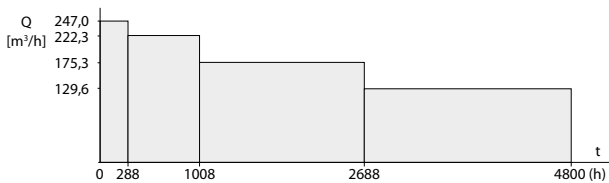

Fig. 4a

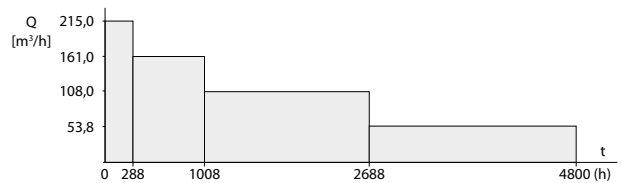

Fig. 4b

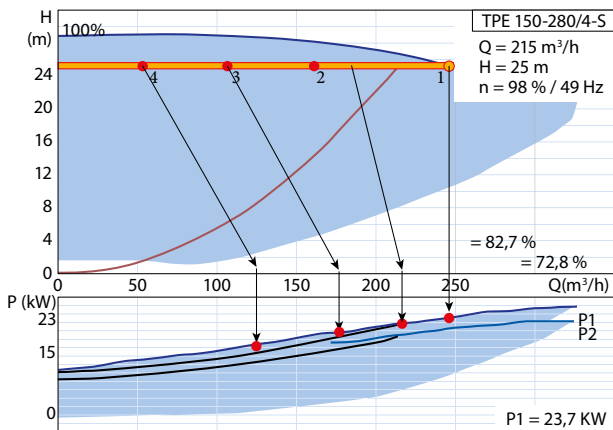

Fig. 5 Pump chart analyses

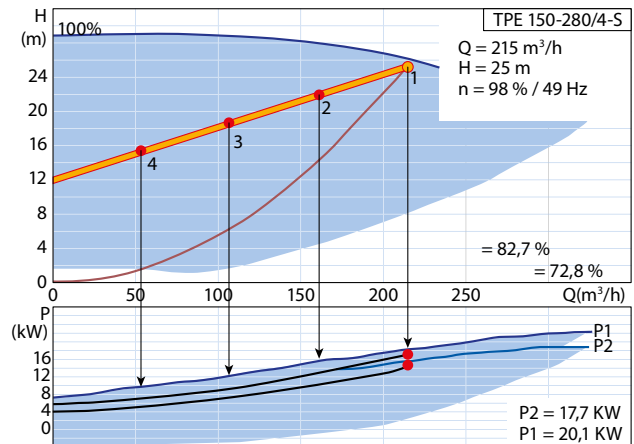

Fig. 6 Pump chart analyses

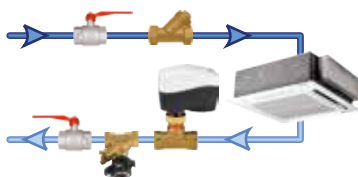

Fig. 7 application 2: with overflow problem (not recommended)

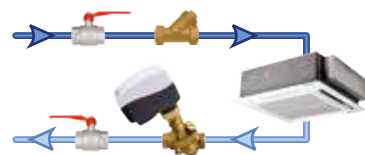

Fig. 8 application 3: without overflow problems (recommended)

The required pump head is approximately the same in all of the three cases with a couple of kPa differences (considering pipe system, general elements, balancing equipments in different systems). For the sake of easier comparison, 1-2 kPa difference is neglected (compared to 250 kPa) and the same operating point is used as starting point.

To calculate the accurate energy consumption of the pump, load-frequency has to be integrated for the whole season. This would be unnecessary and complicated, therefore a four-step approximation given by pump manufacturers is applied. Fig. 4a and 4b shows load-frequency diagram of a 200-day season.

The pump chart above shows load frequency of 200-day season (project location in geographic zone which required 200-day operation, another zone has to be recalculated) .

Fig. 5 shows pump control, which applies to static control and maintains constant differential pressure (application acc. fig. 7). It also shows pump characteristic curve together with pump energy consumption. Since the model calculation is already available, it is known that there is 42 % more water circulating in the system at half load (more than that at ¼ load – about twice as much; less at ¾ load – only 20%). Therefore pump power consumption has to be calculated with “increased” flow (see black arrows) , due to overflow phenomenon. With this knowledge, full energy consumption of the pump per season can be calculated easily. The course of the calculation can be followed in table 9, where pumping cost is also shown based on 0,084 €/ kWh (low voltage, single tariff, public works tariff, without base fee and VAT) energy price. Cost / year / fan-coil are calculated by dividing total consumption by the number of units (941 units.).

Nominal flow demand compare to 100 % load	The real flow [m³/h]	Pump energy consumption [kW]	Incidence	Day/year	Hours a year	Energy consumption
application 1						
100%	247,00	23,70	6,00%	12	288	6825,6
75%	247,00	23,70	15,00%	30	720	17064
50%	247,00	23,70	35,00%	70	1680	39816
25%	247,00	23,70	44,00%	88	2112	50054,4
Summ:			100,00%	200	4800	113760
Pumping cost:	€/ year					9555,84
Cost/fan coil:	€/ FCU					10,15
application 2						
100%	247,00	23,70	6,00%	12	288	6825,6
75%	222,30	20,30	15,00%	30	720	14616
50%	175,37	17,60	35,00%	70	1680	29568
25%	129,68	15,10	44,00%	88	2112	31891,2
Summ:			100,00%	200	4800	82900,8
Pumping cost:	€/ year					6963,67
Cost/fan coil:	€/ FCU					7,40
application 3						
100%	215,00	20,10	6,00%	12	288	5788,8
75%	161,25	14,52	15,00%	30	720	10454,4
50%	107,50	9,27	35,00%	70	1680	15573,6
25%	53,75	6,01	44,00%	88	2112	12693,12
Summ:			100,00%	200	4800	44509,92
Pumping cost:	€/ year					3738,83
Cost/fan coil:	€/ FCU					3,97

Table 9

Fig 6 shows proportional pump control that applies to dynamic control and its characteristic curve together with power consumption of the pump application on fig 8. It is known that there is no additional flow in the system in the case of dynamic control. Therefore arrows pointing to energy consumption are vertical this time. With this knowledge, energy consumption per season can easily be calculated.

For constant flow system, no data other than indicated in calculating table are shown (table 9), since characteristic curve of the pump is unaltered (constant flow system).

Costs per fan-coil are highlighted, which lead us to the following conclusions:

- **The pumping energy demand of the variable flow static system is 70,6% higher** than that of the dynamic system, **which means almost 3,43 € extra cost per fan-coil per year (application based on fig.2 is not recommended by Danfoss).**
- **The pumping energy demand of the constant flow system is more than double** compared to the dynamic system, **which means 6,20 € extra cost per fan-coil per year.**
- **The most economic system is the dynamic control.**

4.2 Investment cost comparison

Scheme of installation is presented below in illustration. Two pipe horizontal systems distributes water to 10 risers. The illustration shows that on all 15 stories of the building, there are 6-7 terminal units on a branch with common balancing valves. Maximum velocity in horizontal pipes 2,2 m/s, in risers 1,5 m/s in branches 1,0 m/s. The investment cost comparison was done for three different applications presented in chapter 4.2 fig – application 1, application 2 and application 3.

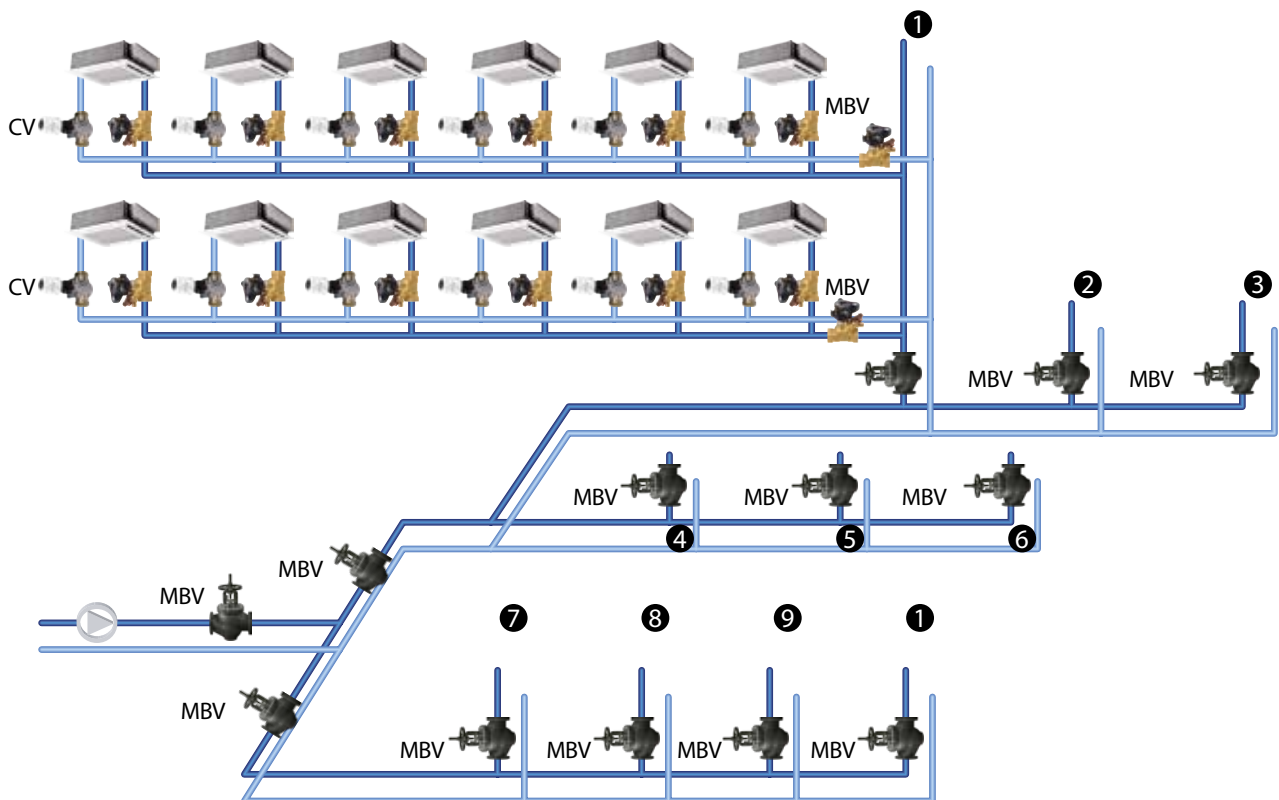

To make project investment comparison between particular application, we have to consider each application individually first:

- application 1: three way control valves with on/off thermal actuators regulation were applied to manual balancing valves. To ensure correct method of balance , the system manual valves are considered in risers and in branches (a compensated method can be used to optimize the pump head) (MSV). Such kind of application always requires a large dimension of manual balancing valves which influences the final investment cost. Project product request :

- control valves : 941 pcs VZ3 with TWA actuators
- balancing valves : 941 pcs of thread MSV valves on FCU
- balancing valves : 150 pcs of thread MSV valves in branches
- balancing valves : 13 pcs flange valves MSV on risers etc.

- application 2: two way control valves with on/off thermal actuators (VZ2 with TWA). For hydraulic balance, manual balancing valves are used, as above. This application also requires a large dimension of manual balancing valves (horizontal pipes, risers). One additional comment has to be made here, as many project contractors try to avoid this valve which finally leads to large problems with the wrong hydraulic regulation. Please note that traditional control valves cannot be used for hydraulic regulation as the system has to be balanced properly when all control valves are fully open. Project product request :

- control valves : 941 pcs VZ2 with TWA actuators
- balancing valves : 941 pcs of thread MSV valves on FCU
- balancing valves : 150 pcs of thread MSV valves in branches
- balancing valves : 15 pcs fange valves MSV on risers etc.

- application 3: Pressure Independent Balancing & Control Valves type AB-QM. As AB-QM are combined valves where each valve has the function of control and balancing. As balancing function is automatic, such kind of application doesn't require additional balancing valves on the branches, risers and horizontal pipes. Project product request :

- control valves : 941 pcs AB-QM with TWA actuators

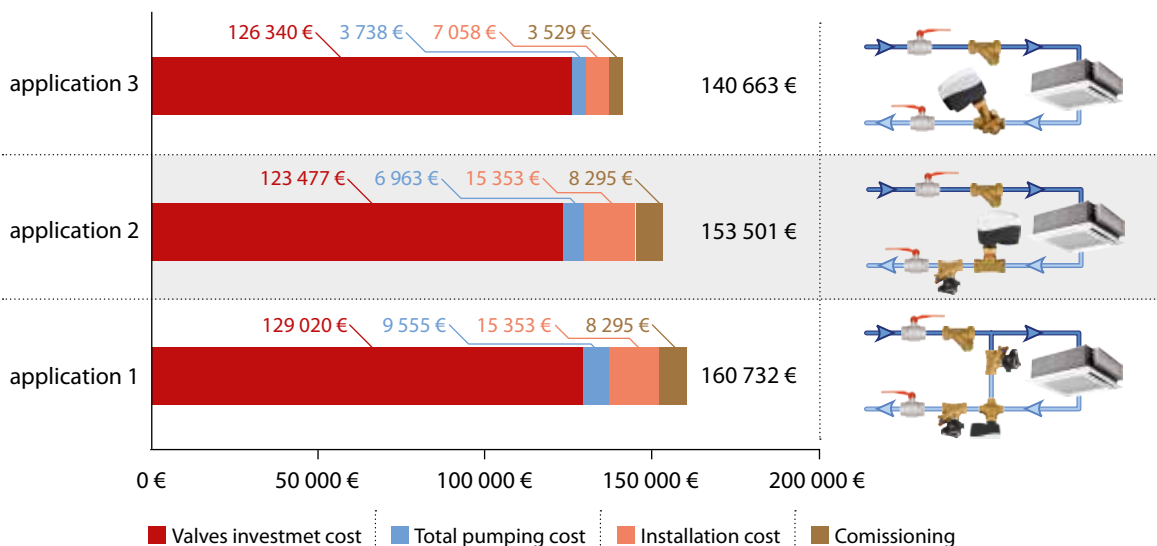

Total cost comparison was done based on Danfoss catalogues prices list.

Conclusion from the project cost study :

- From product investment point of view, the most attractive application is application 2. However another crucial factor which, from the investment point of view should be analysed, indicates that application 3 is in this particular project the most attractive. The total indicated difference between application 3 and 2 is 10 % , where between 3 and 1 it is almost 16%!
- Pressure Independent Balancing & Control Valves like AB-QM provide excellent results from an investment and operation point of view.

- The case study (due to simplifying of the materials) does not include factors like :
 - Design process (simple calculation, authority control valves verification, etc)
 - Heat losses/gains influencing energy consumption
 - Overflow and over pump head in the case of the manual balancing solution with often acceptable accuracy +/- 15 % of nominal flow.
 - Stable and accuracy room control influencing electrical energy consumption
 - High/low chiller efficiency influenced by delta T syndrome
 - Comfort and high worker efficiency due to stable room condition
 - More time needed for the installation of large heavy flange valves
 - Higher investment cost for valve insulation

- Each project has to be analysed individually and the result of total cost comparison depends on:
 - Size of the projects – wide, broad system with a large dimension of distribution pipes that require the installation of a number of big flange valves can indicate a much higher investment cost compared to the application with PIBCV valves!
 - Pumping cost depends significantly on the type of building: a commercial building such as an office will indicate different figures compared to a hotel or a hospital etc.
 - Overflow phenomenon depending on the size of the installation the valve achieves from 40 to 80 % of nominal flow.

4.3

Hydronic analyzer case study (Sunway Lagoon Hotel)

Danfoss has developed a tool, the Hydronic Analyzer, which can be used to analyze the efficiency of a hydronic installation and determine energy saving potentials. The hydronic analyzer is essentially a temperature recorder with which we can register temperatures over a long period of time. To analyze a system we attach 4 sensors to measure supply and return temperatures of the water and the air. After measuring for a certain period Danfoss can compare solutions by using advanced software.

The Sunway Lagoon, a five star hotel in Kuala Lumpur, had decided to renovate the rooms. Although the owners of the hotel were positive about the use of AB-QM pressure independent balancing and control valves, they wanted to have some additional proof for the possible savings and benefits.

The hotel has about 500 fan coil units that were originally equipped with a conventional solution, a 2-way control valve and a manual balancing valve. When the first phase of the hotel renovation was finished, one third of the hotel rooms were equipped with about 150 pieces of AB-QM. At that time Danfoss offered the hotel owner to test the system with the hydronic analyzer comparing the two solutions, conventional and the AB-QM. The results of the analysis showed significant energy saving potential both on the energy for pumping and the efficiency of the chiller. Upgrading of all 500 fan coil units with AB-QM will improve the efficiency of the chiller and save on pumping, about 60% on the overall energy bill.

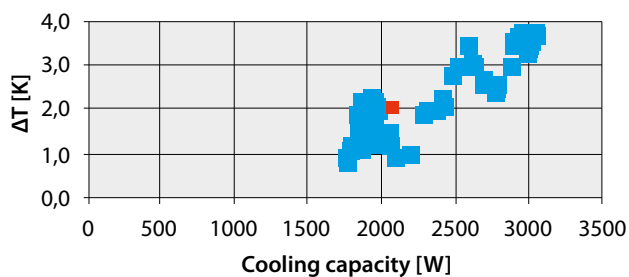
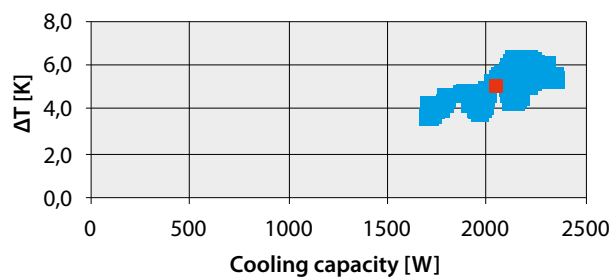

Figure 1

■ ΔT ■ Average ΔT



■ ΔT ■ Average ΔT

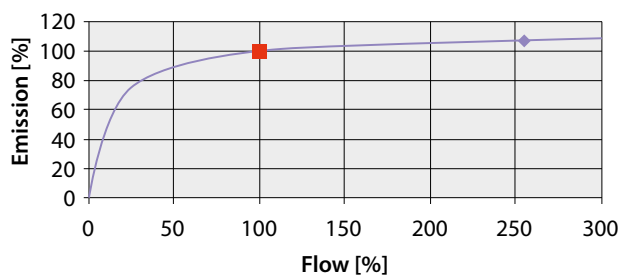

Figure 2

■ AB-QM ◆ Traditional valve

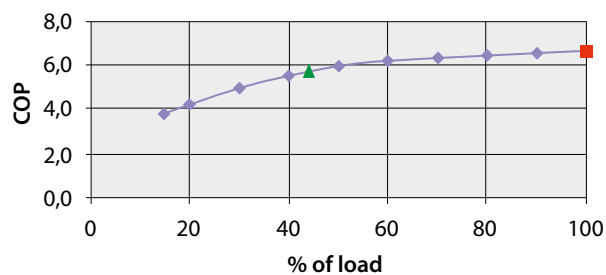

Figure 3

■ AB-QM ▲ Traditional valve

Figure 1 shows the relation between the ΔT and the cooling capacity measured at the fan coil unit. The left graph represents the result of measurements on the fan coil units with a traditional control valve and manual balancing valve. The graph on the right side represents a fan coil units equipped with AB-QM.

Results: In the left graph the average ΔT is 2°C, the cooling capacity is 2,2 kW and in the right graph the average ΔT is 5°C, and the cooling capacity is 2,1 kW. We can therefore conclude that with the AB-QM the cooling capacity is practically the same while the ΔT increases significantly. This will substantially increase the efficiency of the chiller as can be seen in figure 3.

Figure 2 shows graphically the relation between the heat exchangers relative emission and the relative flow.

In the case of the traditional control valve with manual balancing valve there was a 250% overflow which contributes less than 10% to the total fan coil emission, in comparison to the fan coil with AB-QM.









Figure 3 shows graphically the relation between the co-efficiency of the performance and the chiller load percentage.

Overflow through the fan coils causes inefficient chiller operation due to the so-called low ΔT syndrome (see chapter 3.1). Furthermore, because less water needs to be pumped for a similar capacity, the pump speed can be more than halved resulting in substantial energy saving on pumping energy.

5. Product overview

5.1 ABPCV – Automatic Balancing Pressure Control Valves



Differential pressure controller

Picture	Name	Description	Size (mm)	Kvs (m3/h)	Appl. RH-C/ HVAC*	Comments
	ASV-P	Differential pressure controller in the return pipe with fix 10 kPa pressure setting	15... 40	1,6... 10	RH	Integrated shut off and draining possibility
	ASV-PV	Differential pressure controller in the return pipe with adjustable 5-25 or 20-40 kPa pressure setting	15... 40	1,6... 10	RH and HVAC	Integrated shut off and draining possibility
	ASV-M	Flow pipe mounting valve, impuls tube connection, shut off function,	15... 50	1,6... 16	RH and HVAC	Used with ASV-P or PV together mainly for shut of function
	ASV-I	Flow pipe mounting valve impuls tube connection, presetting, measuring possibility, shut off function	15... 50	1,6... 16	RH and HVAC	Used with ASV-PV valve together mainly for flow limitation function
	ASV-BD	Flow pipe mounting valve impuls tube connection, presetting, measuring possibility, shut off function	15... 50	3... 40	RH and HVAC	Used with ASV/P or PV together, big capacity, measurement, shut off function
	ASV-PV	Differential pressure controller with adjustable 20-40, 35-75 or 60-100 kPa pressure setting	50... 100	20... 76	All	Used with MSV-F2 in the flow pipe for shut off, flow limiting and impulse tube connection
	AVDO	Pressure relief valve with setting range 5... 50 KPa	15... 25	2,39... 5,98	All	Bigger dimension is available
	AB-PM	Pressure Independent Balancing and Zone Valve	15... 25	0,06 ... 1,2 ($\Delta p=10$ kPa)	RH	Max. flow capacity depends on Δp demand of controlled loop

5.2 PIBCV: Pressure Independent Balancing & Control Valves

PIBCV without actuators : Automatic Flow Limiter

PIBCV with actuators : Pressure Independet Control Valves with Balancing function

Picture	Name	Description	Size mm	Flow m3/h	Appl. RH-C/ HVAC	Comments
	AB-QM	Pressure independent balancing control valve, with or without measuring nipple	10... 32 40,50	0,03... 3,2 1,5... 12,5	RH, HVAC	Combined with actuator ensures high end flow control – logarithmic characteristic
	AB-QM	Pressure independent balancing control valve, with measuring nipple	50... 250	5,0... 442	HVAC	Combined with actuator ensures high end flow control – logarithmic characteristic

* RH: Residential heating



RC: Residential cooling

HVAC: Non residential application (Heating Ventilation Control)









Actuators for AB-QM valves

Picture	Name	Description	Usage with AB-QM	Speed (s/mm)	Control type	Comments
	TWA-Z	Thermal actuator with 24V and 230V power supply, visual positioning indicator	DN10-20, DN25,32 up to 60%	60	ON/OFF	Available in both NC and NO version, closing force 90 N
	ABNM, ABNM-Z	Thermal actuator with 24V power supply, visual positioning indicator	DN10-20, DN25,32 up to 90%	30	0-10V	LOG or LIN stroke movement, only NC version is available, closing force 100 N
	AMI 140	Gear actuator with 24V and 230V power supply, positioning indicator	DN10 -DN32	12	ON/OFF three wire	Factory setting NC version, change over possibility to NO, closing force 200N
	AMV/E 110NL, 120NL	Gear actuator with 24V power supply, positioning indicator	DN10 -DN32	12 and 24	3-point, 0-10V	Gap detection ensures precise control independently from the presetting of AB-QM
	AMV/E 13 SU, 23 SU	Gear actuator spring up with 24V and 230V power supply, hand operation	DN10 -DN32	14 and 15	0-10V	Spring up: frost protection
	AMV/E 25 SD/SD	Gear push-pull actuator spring UP/DOWN with 24V and 230V power supply	DN40 – DN100	15	0-10V	Spring down: overheating protection, spring up: frost protection
	AMV/E 435 QM	Gear push-pull actuator with 24V and 230V power supply, hand operation, LED indication	DN40 – DN100	7,5–15	3-point, 0-10V	3-point actuator and 230 V power supply is available
	AME 55 QM	Gear push-pull actuator with 24V power supply	DN 40 -150	8	0-10V	3-point actuator and spring return function. 230 V power supply is available
	AME 85 QM	Gear push-pull actuator with 24V power supply	DN 200...250	8	0-10V	3-point actuator and spring return function. 230 V power supply is available

Self acting controller for AB-QM valves

Picture	Name	Description	Size	Setting range	Control type	Comments
	CCR3	Return temperature controller, temperature registration	-	-	Electronic control	Programmable temperature control, data storage
	QT	Self-acting actuator, return temperature controller	DN 10-32	35-50°C, 45-60°C	Proportional control	Xp band 5K at presetting 50% of AB-QM

5.3 MBV: Manual Balancing Valves

Picture	Name	Description	Size (mm)	Kvs (m3/h)	Appl. RH-C/ HVAC	Comments
	USV-I	Flow pipe mounting valve impulse tube connection, presetting, measuring possibility, shut off function	15... 50	1,6... 16	RH and HVAC	Used with ASV-PV valve together mainly for flow limitation function
	USV-M	Return pipe mounting valve, shut off function with drain possibility, normal brass valve body	15... 50	1,6... 16	RH	Upgradable to differential pressure controller (for DN15-DN40)
	MSV-BD	Presetting, with measuring nipple, DZR valve body, closing and drain function	15... 50	2,5... 40	All	Extra large Kvs value, unidirectional valve construction, high accuracy rotary measuring station
	MSV-B	Presetting, with measuring nipple, DZR valve body, closing function	15... 50	2,5... 40	All	Extra large Kvs value, unidirectional valve construction, high accuracy
	MSV-O	Presetting, with measuring nipple, DZR, valve body, closing function and fixed orifice	15... 50	0,63... 38	All	Extra large Kvs value, unidirectional valve construction, high accuracy rotary measuring station
	MSV-S	Closing valve, DZR body	15... 50	3... 40	All	Extra large Kvs value, shut off function, high draining capacity
	MSV-F2	Presetting, with measuring nipple, GG-25 valve body, closing function	15... 400	3,1 – 2585	All	PN 25 version is available
	PFM 4000	Measuring device for manual balancing valve and trouble shooting	-	-	All	Blue tooth or radio communication, PDA based data storage

* RH: Residential heating
 RC: Residential cooling
 HVAC: Non residential application (Heating Ventilation Control)



5.4 MCV : Zone Valve, Motorised Control Valves

Picture	Name	Description	Size mm	Kvs m3/h	Appl. RH-C/ HVAC	Comments
	RA-N	Presetting valve (14 sets) on zone control or self acting room temperature control with thermostatic head	10... 25	0,65... 1,4	RH	Recommended application with central Δp controller
	RA-C	Presetting valve (4 set) on zone control	15... 20	1,2... 3,3	RC, HVAC	Recommended application with central Δp controller
	VZL-2/3/4	Fan-coil valve on zone control with linear valve characteristic	15... 20	0,25... 3,5	HVAC	Short stroke valve applicable with thermal or gear actuator
	VZ-2/3/4	Fan-coil valve on zone or 3-point, proportional control with logarithmic valve characteristic	15... 20	0,25... 4,0	HVAC	Log stroke valve – accurate control
	AMZ 112/113	Zone controller ball valve with high kvs value	15... 50 15... 25	17... 290, 3,8... 11,6	All	With integrated gear actuator
	VRB 2 or 3 port	Traditional log-lin control valve	15... 50	0,63... 40	All	Internal and external thread connection, high control ratio, pressure relieved
	VF 2 or 3 port	Traditional log-lin control valve	15... 150	0,63... 320	All	High control ratio
	VFS 2 port	Traditional logarithmic control valve on steam application	15... 100	0,4... 145	HVAC	PN 25 version, Tmax: 200°C



Actuators for valves

Picture	Name	Description	Usage with valves	Speed (s/mm)	Control type	Comments
	TWA-A, TWA-Z	Thermal actuator with 24V and 230V power supply, visual positioning indicator	RA-N/C, VZL	60	ON/OFF	Available both, NC and NO version, closing force 90 N
	ABNM, ABNM-Z	Thermal actuator with 24V power supply, visual positioning indicator	RA-N/C, VZL	30	0-10V	LOG or LIN stroke movement, only NC version is available closing force 100 N
	AMI 140	Gear actuator with 24V and 230V power supply, positioning indicator	VZ, VZL	12	ON/OFF three wire	Factory setting NC version, change over possibility to NO, closing force 200N
	AMV/E-H 130, 140	Gear actuator with 24V and 230V power supply, positioning indicator	VZL (VZ)	12 and 24	3-point, 0-10V	Closing force 200N, hand operation
	AMV/E 13 SU/SD	Gear actuator spring up with 24V and 230V power supply, hand operation	VZ, VZL	14 and 15	3-point, 0-10V	Spring up: frost protection
	AMV/E 435	Gear push-pull actuator with 24V or 230V power supply	VRB, VF,VFS DN 50	7 or 14	3-point, 0-10V	230V version only on 3-point actuator, built in anti-oscillation algorithm
	AMV/E 25, 35	Gear push-pull actuator with 24V and 230V power supply, hand operation	DN 40-100	3/11	3-point, 0-10V	230V version only on 3-point actuator, built in anti-oscillation algorithm
	AMV/E 25 SD/SD	Gear push-pull actuator spring UP/DOWN with 24V and 230V power supply	DN 40-100	15	3-point, 0-10V	Spring down: overheating protection, spring up: frost protection
	AMV/E 55/56	Gear push-pull actuator with 24V or 230V power supply	VL/VF,VFS DN65-100	8 / 4	3-point, 0-10V	230V version only on 3-point actuator
	AMV/E 85/86	Gear push-pull actuator with 24V or 230V power supply	VL/VF,VFS DN125-150	8 / 3	3-point, 0-10V	230V version only on 3-point actuator

5.5 SARC: Self Acting Room Controllers

Picture	Name	Description	Usage with valves	length of capillar t. (m)	Appl.	Comments
	FEK	Single-stage cooling control, temperature range 17-27°C	RA-C	5 or 2 + 2	cooling	Built in and remote sensor
	FEV	Single-stage heating control, temperature range 17-27°C	RA-N	5 or 2 + 2	heating	Built in and remote sensor
	FED	Two-stage heating/cooling sequence control, temperature range 17-27°C	RA-N, RA-C	4 + 11 or 2 + 2 + 2	heating/ cooling	Built in and remote sensor, settable dead zone 0,5-2,5 °C

5.6 RC : Room Controllers

Picture	Name	Description	Power supply	Full speed control	System	Comments
	RET 230CO 1/2/3/4	Non-programmable room thermostat for heating/ cooling application	230V	without or 3 speed	2 pipe, 4 pipe	Manual change over of function and fan speed
	RESD HC2/HC4	Programmable room thermostat for heating/cooling application	230V	Manual or auto 3 speed	2 pipe, 4 pipe	Automatic change over function, back light, keypad lock, ON/OFF.
	SH-E01	Electronic Solar Heat Regulator	230 V	-	Solar app.	Pump exercise, solar heat output

5.7 DHWC : Domestic Hot Water Controllers

Picture	Name	Description	Size (mm)	Kvs (m3/h)	Function	Comments
	MTCV	Multifunctional thermostatic DHW circulation valve	15... 20	1,5... 1,8	Return tem. limitation	Temp. range 35-60°C, Valve body RG5, max. flow temperature 100°C
	MTCV with B – module	Self acting temperature disinfection module	15... 20	1,5... 1,8	Allow thermic desinf.	Built in by-pass for start of thermic disinfection process
	CCR2	Disinfection process controller and temperature registration electronic, 24V power supply	-	-	Electronic control	Programmable disinfection process, data storage
	TWA-A	Thermal actuator with 24V power supply, visual positioning indicator	-	-	ON/OFF control of desinf.	Available both, NC and NO version, closing force 90 N
	ESMB, ESM-11	Temperature sensors	-	-	Temp. reg., start desinf.	PT 1000, more different shape sensors are available
	TVM-W	Temperature mixing valve	20	1,9 (1,65)	Tapping temp. limitation	Built in temperature sensor, external thread
	TVM-H	Temperature mixing valve	20... 25	1.9... 3.0	Tapping temp. limitation	Built in temperature sensor, external thread

NOTES

A series of horizontal lines for taking notes, consisting of 25 evenly spaced lines that span the width of the page.



Location: Shanghai, China
Project: World Expo Performance Center
Application: AB-QM for heating and cooling



Location: Doha, Qatar
Project: Barwa Commercial Avenue
Application: AB-QM for cooling



Location: Seoul, South Korea
Project: D-Cube city and shopping mall
Application: AB-QM for heating and cooling



Location: Frankfurt, Germany
Project: Silver Tower
Application: AB-QM for heating and cooling



Location: Istanbul, Turkey
Project: ING bank
Application: AB-QM for heating and cooling

Danfoss A/S

Heating Solutions • Hydronic Balancing & Control • Ulvehavevej 61 • DK-7100 Vejle • Denmark
Telephone +45 7488 8500
Email: heating@danfoss.com
www.hbc.danfoss.com

Cover picture: Lyceum Ypenburg by DP6 Architecten – The Hague – The Netherlands

Danfoss can accept no responsibility for possible errors in catalogues, brochures and other printed material. Danfoss reserves the right to alter its products without notice. This also applies to products already on order provided that such alterations can be made without subsequential changes being necessary in specifications already agreed. All trademarks in this material are property of the respective companies. Danfoss and the Danfoss logo are trademarks of Danfoss A/S. All rights reserved.