

EAN: 6414150023576

www.oras.com/en/products/oras/product/421025

- Technical room



Technical data

Technical properties

DN-size (nominal dimension)

DN25

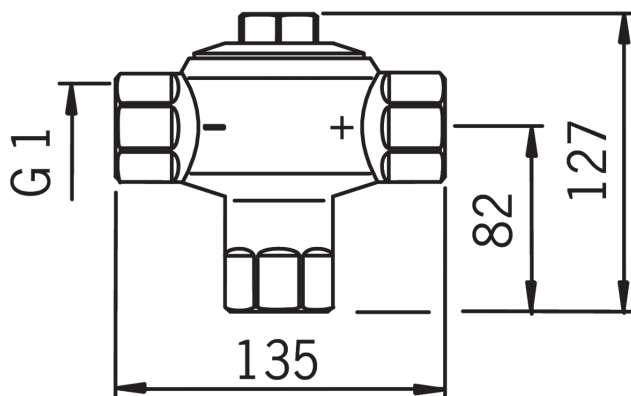
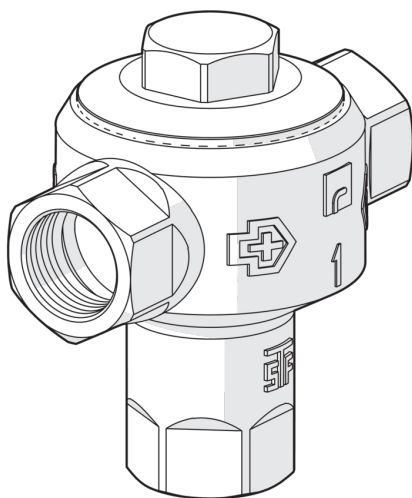

Spare parts

SP4210

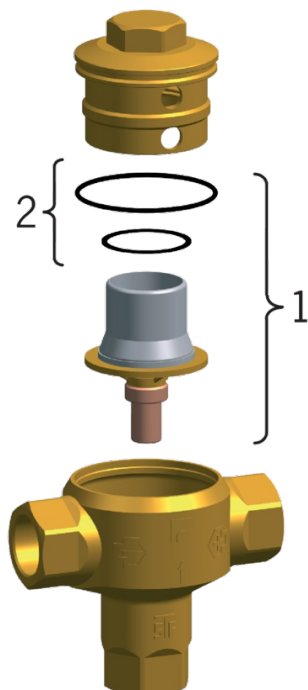

	Code
01	428161V
01	428160V
01	428168V
01	428167V
02	428158V