

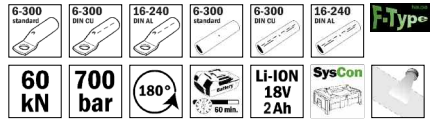

**Battery powered crimping tool
„SO-6“**

Art. 216801



1. Technical data

Area of application:	For the creation of an electrical connection by means of compression
Scope of delivery:	1 crimping tool, 1 charger, 1 battery, 1 carry loop, in plastic case, without pressing dies.
Pressing force:	60 kN
Oil type:	ISO class viscosity 15
Safety:	The tool is fitted with a safety value that has been set at the factory.
Structure:	The working head can be rotated by 180° to make it easier to adapt to the operation to be carried out. The model Art. 216801 does not protect the operator when working on cables that carry power.
Guarantee:	2 year guarantee if used for the purpose it is intended.

2. Area of work/Performance characteristics

- Pressing force in kN 60 kN
 - Working pressure in bar: 700
 - Head can be opened
 - Opening / Hub: 17 mm
 - Pressing width: slim
 - Motorstop
 - Crimping range cable lugs: standard Cu 6-300 / DIN Cu 6-300 / DIN Al 16-240
 - Crimping range connectors: standard Cu 6-300 / DIN Cu 6-300 / DIN Al 16-240
 - Pressing time, battery-operated in seconds: 5
 - Battery charging time in minutes: 60
 - Battery type: Li-Ion, 18 V, 2 Ah | Weight in kg: 0.38
 - Weight machine in kg without batterie: 2.9
 - Weight set in kg: 7.1
-
- 6 tonnes of pressing force for maximum performance
 - Motor stop. The feed is stopped immediately the operating switch is released. No post-travel of the piston
 - 180 degree rotating crimping head. Can thus be mounted even in places that are difficult to access
 - Manual return enables shorter process cycles and saves battery capacity
 - The manual return enables the operator to bring the piston back to the starting point in the event of a faulty pressing.
 - After the pressing is completed, the device operates in idle.
(If the compression is not completed, manual return of the piston on the return operation button is "very perceptibly" more difficult)
 - The two button operation ensures logical, simple and quick single-handed operation.
 - The tool is supplied with 1 Li-Ion battery 18 V, 2 Ah and a quick charger.
 - Area of application in accordance with the available pressing dies
 - (max. 300 mm² DIN tube terminals or 300 mm² F-Type notch-type cable keys for cable class 5/6).

3. Operating instructions

CAUTION! TOOLS MAY NEVER BE USED WITHOUT FIRST INSERTING THE PRESSING DIES.

Ensure that the pressing dies fit precisely to the appropriate area and are seated perfectly in the holders.

OTHERWISE THIS MAY CAUSE SERIOUS DAMAGES OR BREAKAGES AND THE GUARANTEE WILL BE VOIDED.

Preparation

Before starting up the tool, read the operating instructions first.

All current-carrying elements in the area you are working in should be disconnected.

Otherwise the protective procedures for working in the vicinity of components under current must be implemented. (DIN EN 50110)

Do not use the tool if you are tired or under the influence of medication, drugs or alcohol.

Take into account the valid accident prevention and safety regulations and use the tool exclusively for the purpose for which it is intended.

Only electro-technically trained persons over 16 years of age may process connecting materials using the tool.

The operating instructions must always be carried with the tool.

The instructions must have been read and understood by the user.

The operator must ensure that this is the case.

Operating:



- Select the required pressing die.
- Never use a crimping tool without pressing dies!
- The pressing procedure can be stopped at any time by releasing the actuation switch.
- No components under power may be compressed.
- The tool is not insulated!
- The tool is not designed for permanent use.
- After 35 - 45 compression actions carried out one after another, you must take a break of 10 to 15 minutes to allow the tool to cool down.
- If it is heated too high, this may cause damages to the tool.
- Do not use under water or when it is raining.
- Please observe the processing notes for the relevant connection materials as detailed in our catalogue.

4. Removing and inserting the battery

Hold the tool firmly and press the battery release button to remove the battery.

ATTENTION:

Never short-circuit the battery.

Inserting the battery

Insert the battery until it clicks into place. Make sure the poles are facing the right way



Charging

Before using the tool, charge the battery as follows: Connect the cable of the charger to a socket (AC).

Inserting the battery into the charger

Insert the battery firmly, as shown in here until it touches the bottom of the charging compartment.

ATTENTION:

If the battery is inserted incorrectly, it will not only not be charged, it may also damage the charger (e.g. by bending the terminals/short-circuiting).

Charging

When you insert a battery into the charger, the battery is charged and the charging light.

When the battery is fully charged, the charging indicator shows 100% and a beep.

Remove the battery immediately and disconnect the charger from the mains.



Attention!

Please remove the battery during transport and after usage – because of avoiding deep discharge!

haupa[®]

... convincing solutions

Li-ion Battery & Charger Instruction



Li-ion Batterie

Voltage	18 V
Weight	0,380 kg
Length	120 mm
Width	70 mm
Height	50 mm
Capacity(Ah)	2 Ah
Charge time	60 min.

Charge(for Li-ion)





Voltage	110V / 220V
Weight	0,430 kg
Length	175 mm
Witdh	90 mm
Height	80 mm







Permitted only on stabilized power sources!
Charging only for HAUPA batteries!

Li-Ion Battery Manual Instruction

Panel Description:

1. Connect power shows  ,
2. Fully charged, it shows  and comes beeping every 3 seconds.
3. Unusual working == Too low voltage shows  and comes a beeping every second.
4. Unusual working == Unusual temperature shows  , and comes a beeping every second.
5. The voltage is not rising after 10 minus charged. The battery is charged incompletely. The battery is faulty, showing  and coming beeping every 2 seconds by a second.

Specification:

1. The input power is external power DC24V 3A。
2. The charge voltage is 24V 2.5A。
3. When plug in the power, the panel shows  and comes a beeping.
4. Uninstall the battery, the panel shows  and twinkles every second.
5. Detect the battery voltage first and shows battery capacity rate when install battery.
6. When battery charged completed, the panel shows  and comes beeping every 3 seconds.
7. When the voltage is too low, the panel shows  and comes a beeping every second.
8. When the temperature is too high, the panel shows  and comes a beeping every second.
9. The maximum charge time is 70 minutes. After 70 minutes, the charger will stop charging regardless the battery is charged completed.
10. The full charged voltage for 18V Li-Ion battery is (5*4.3=21.5v); the voltage for 14.4V Li-Ion is (4*4.3=v17.2v) (reference valve). The battery is coming with a protective plate which will stop charging automatically when charged completely.
11. The lowest battery voltage for 18V Li-Ion battery is (2.9*5=14.5v); and the 14.4v is (2.9*4=11.6v).
12. It will stop charge when the battery temperature is higher than 65 degree centigrade.
13. The usual temperature for battery is between -20° to 65° centigrade when a fan is applied. The fan working voltage is 12V.
14. Under 90% battery capacity will carry in adding per 5%. Over 90% battery capacity will carry in adding per 1%.

5. Care and maintenance

Cleaning

- Careful cleaning of the tool, in particular, the moving parts contributes towards a longer useful life. Remember that dust, sand, environmental influences, in particular a high salt index, and dirt in general are extremely damaging to hydraulic tools.
- Particular care should be taken when cleaning the pump drive piston and the piston. The tiniest of contaminations may scratch the walls of the cylinder and damage the leak-proof seals. For the correct cleaning of the piston, we recommend extending the piston and then cleaning it with a high-quality, non-corrosive solution.

Power switch

Check to see whether the switch on the machine automatically pops out again when you release it.

Storage

To prevent damage to the tool as a result of bumps, dust etc. you should if possible store the tools in the original packaging.

Guarantee:

2 year guarantee when used for the purpose it is intended when the annual maintenance intervals are maintained by an authorised HAUPA service centre. We reserve the right to rework the product.

Faults:

Loss of oil:

Send to the HAUPA service centre. Do not open!

Disposal:

...in accordance with the scope of validity of the European WEEE (2002/96/EU) and RoHS directives (2002/95/EU). Batteries must be disposed off separating according to the battery directive.

WITH EVERY REPLACEMENT PART ORDER, INCLUDE THE FOLLOWING INFORMATION:

- 1) Article number.
- 2) Article description.
- 3) Reference to the operating instructions and/or date.
- 4) Tool type.
- 5) Serial number of the tool.

The guarantee is voided if you use parts that are not original replacement parts from HAUPA.

Exploded assembly drawing art. art. 216801

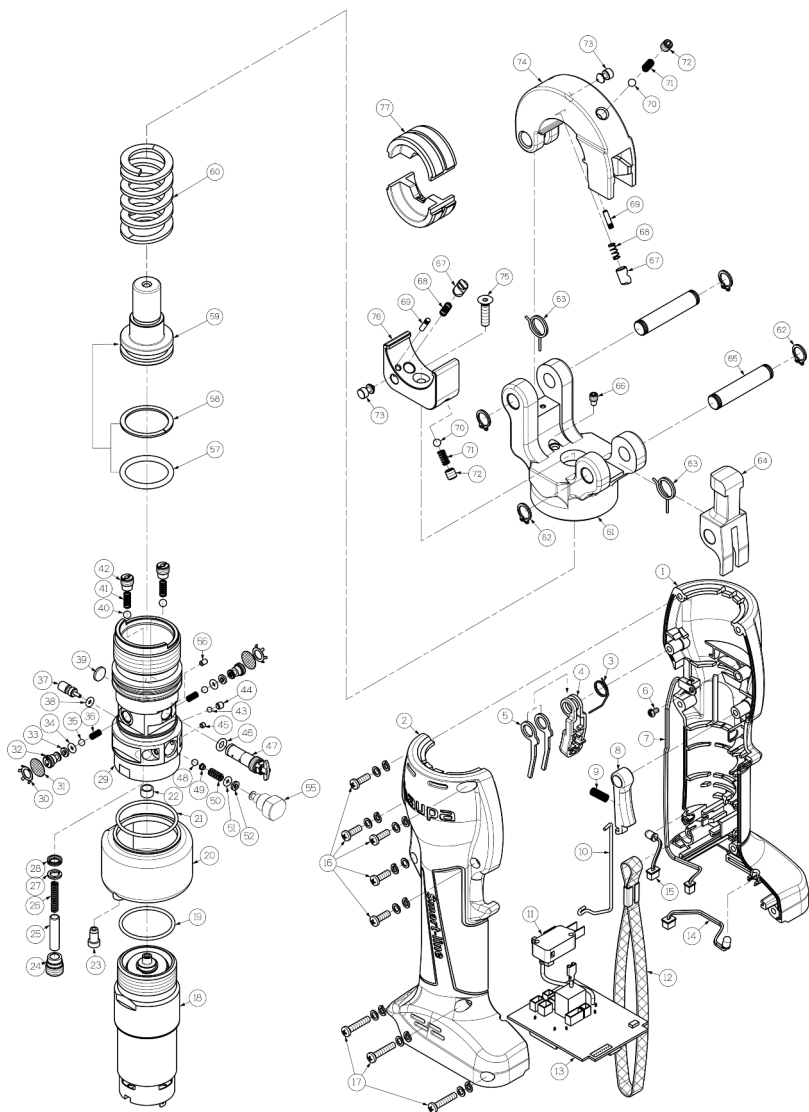

haupa[®]

... convincing solutions

EC declaration of conformity HAUPA factory certificate

Remscheid, 23.03.2016

Product: Battery hydraulic crimping tool
Product range: Around the cable
Art. no.: 215770; 215770/M; 215881; 215881/M; 216800;
216801; 216801/M; 216601; 216622; 216503; 216663;
216663/M; 216667; 216667/M; 216669; 216669/M

Note: A correct connection according VDE 0220 Part 2 is only guaranteed if the user work with Haupa cable lugs and also adequate HAUPA pressing tools.

The tools are not isolated and it is forbidden to work under tension.

HAUPA GmbH & Co.KG, Königstr. 169, 42853 Remscheid, Germany
Phone +49 2191 8418 - 0, Fax +49 2191 8418 - 840

Herewith we declare that the above mentioned tools are manufactured according the following guidelines:

CE guidelines 98/37/EEC, 89/336/EEC



Jens-Ole Paas
Qualitätsmanagement



Jochem Husli
Produktmanagement