





# **XC640D**

**(v. 3.0)**

# INDEX

<b>1.</b>	<b><u>BEFORE PROCEEDING</u></b>	<b>5</b>
1.1	CHECK THE SW REL. OF THE XC640D	5
<b>2.</b>	<b><u>GENERAL WARNING</u></b>	<b>5</b>
2.1	 PLEASE READ BEFORE USING THIS MANUAL	5
2.2	 SAFETY PRECAUTIONS	5
<b>3.</b>	<b><u>GENERAL DESCRIPTION</u></b>	<b>6</b>
<b>4.</b>	<b><u>PROBES RELATED TO THE XC640D</u></b>	<b>7</b>
4.1	PP07, PP11, PP30 PP50: 4÷20MA PRESSURE TRANSDUCERS	7
4.2	NP4-67: PIPE MOUNTING TEMPERATURE PROBE	7
<b>5.</b>	<b><u>WIRING &amp; ELECTRICAL CONNECTIONS</u></b>	<b>8</b>
5.1	GENERAL WARNINGS	8
5.2	WIRING CONNECTIONS	8
5.3	PROBES CONNECTION	8
5.4	LOAD CONNECTIONS	9
5.5	SAFETY AND CONFIGURABLE DIGITAL INPUTS – FREE VOLTAGE	10
5.6	CIRCUIT WITH 1 SUCTION AND 1 CONDENSER: HP – LP PRESSURE SWITCH CONNECTIONS	10
5.7	CIRCUIT WITH 2 SUCTIONS AND 1 CONDENSER: HP – LP PRESSURE SWITCH CONNECTIONS	11
5.8	ANALOG OUTPUT CONNECTION	11
5.9	HOW TO CONNECT MONITORING SYSTEM - RS485 SERIAL LINE	11
<b>6.</b>	<b><u>MOUNTING &amp; INSTALLATION</u></b>	<b>12</b>
<b>7.</b>	<b><u>FIRST INSTALLATION</u></b>	<b>12</b>
7.1	HOW TO SET THE KIND OF GAS	12
7.2	HOW TO SET THE RANGE OF THE PRESSURE PROBES	13
<b>8.</b>	<b><u>USER INTERFACE</u></b>	<b>14</b>
8.1	DISPLAYING	14
8.2	KEYBOARD	14
8.3	ICONS	15
<b>9.</b>	<b><u>HOW TO SEE AND MODIFY THE SET POINT(S)</u></b>	<b>15</b>
9.1	HOW TO SEE THE SET POINT OF COMPRESSORS AND/OR FANS	15
9.2	HOW TO MODIFY THE SET POINT OF COMPRESSORS AND/OR FANS	16
<b>10.</b>	<b><u>THE INFO MENU</u></b>	<b>17</b>
<b>11.</b>	<b><u>PARAMETERS PROGRAMMING</u></b>	<b>17</b>
11.1	HOW TO ENTER THE “PR1” PARAMETER LIST	17

11.2	HOW TO ENTER IN PARAMETERS LIST "Pr2"	18
11.3	HOW TO CHANGE PARAMETER VALUES	18
<b>12.</b>	<b>HOW TO DISABLED AN OUTPUT</b>	<b>19</b>
12.1	HOW TO DISABLED AN OUTPUT DURING A MAINTENANCE SESSION.	19
12.2	OUTPUT DISABLED SIGNALING.	19
12.3	REGULATION WITH SOME OUTPUTS DISABLED.	19
<b>13.</b>	<b>RUNNING HOURS OF LOADS</b>	<b>19</b>
13.1	HOW TO DISPLAY THE RUNNING HOURS OF A LOAD.	19
13.2	HOW TO RESET THE RUNNING HOURS OF A LOAD.	19
<b>14.</b>	<b>ALARM MENU</b>	<b>20</b>
14.1	HOW TO SEE THE ALARMS	20
<b>15.</b>	<b>KEYBOARD LOCKING</b>	<b>20</b>
15.1	HOW TO LOCK THE KEYBOARD	20
15.2	TO UNLOCK THE KEYBOARD	20
<b>16.</b>	<b>USE OF THE PROGRAMMING "HOT KEY "</b>	<b>21</b>
16.1	HOW TO PROGRAM A HOT KEY FROM THE INSTRUMENT (UPLOAD)	21
16.2	HOW TO PROGRAM AN INSTRUMENT USING A HOT KEY (DOWNLOAD)	21
<b>17.</b>	<b>LIST OF PARAMETERS</b>	<b>22</b>
17.1	PLANT DIMENSIONING AND TYPE OF REGULATION.	22
17.2	PROBES CONFIGURATION	25
17.3	CONFIGURABLE DIGITAL INPUTS CONFIGURATION	26
17.4	DISPLAY AND MEASUREMENT UNIT	27
17.5	COMPRESSOR REGULATION	28
17.6	LIQUID INJECTION THERMOSTAT	29
17.7	FANS REGULATION	29
17.8	ALARMS – COMPRESSOR SECTION	29
17.9	ALARMS – FANS SECTION	30
17.10	DYNAMIC SET POINT FOR FAN	30
17.11	ANALOG OUTPUT 1 (OPTIONAL) – TERMINALS 25-26	31
17.12	ANALOG OUTPUT 2 (OPTIONAL) – TERMINALS 27-28	31
17.13	OTHER	32
<b>18.</b>	<b>EVEN CAPACITY COMPRESSORS (CTYP = SPO)</b>	<b>33</b>
18.1	COMPRESSORS WITH SAME CAPACITY – DEAD BAND CONTROL	33
<b>19.</b>	<b>UNEVEN CAPACITY COMPRESSORS (CTYP = DPO)</b>	<b>34</b>
<b>20.</b>	<b>SCREW COMPRESSORS (CTYP = SCR)</b>	<b>34</b>
20.1	REGULATION WITH SCREW COMPRESSORS LIKE BITZER/ HANBELL/ REFCOMP ETC	35
<b>21.</b>	<b>FAN REGULATION</b>	<b>36</b>
21.1	CONDENSER WITH INVERTER OR ECI FANS–ANALOG OUTPUT SETTING	36
<b>22.</b>	<b>ALARM LIST</b>	<b>38</b>

22.1	TYPES OF ALARMS AND SIGNALING MANAGED	38
22.2	BUZZER MUTING	41
22.3	ALARM CONDITIONS – SUMMARY TABLE	41

**23. TECHNICAL FEATURES** **44**

**24. PARAMETERS – DEFAULT VALUES** **45**

## 1. BEFORE PROCEEDING

### 1.1 Check the sw rel. of the XC640D

1. Look at the SW rel. of XC64D printed on the label of the controller.



2. If the SW release is 3.0, proceed with this manual otherwise contact Dixell to get the right manual.

## 2. GENERAL WARNING

### 2.1 Please read before using this manual

- This manual is part of the product and should be kept near the instrument for easy and quick reference.
- The instrument shall not be used for purposes different from those described hereunder. It cannot be used as a safety device.
- Check the application limits before proceeding.
- Dixell Srl reserves the right to change the composition of its products, even without notice, ensuring the same and unchanged functionality.

### 2.2 Safety Precautions

- Check the supply voltage is correct before connecting the instrument.
- Do not expose to water or moisture: use the controller only within the operating limits avoiding sudden temperature changes with high atmospheric humidity to prevent formation of condensation
- Warning: disconnect all electrical connections before any kind of maintenance.
- The instrument must not be opened.
- In case of failure or faulty operation send the instrument back to the distributor or to "Dixell S.r.l." (See address) with a detailed description of the fault.
- Consider the maximum current which can be applied to each relay (see Technical Data).
- Ensure that the wires for probes, loads and the power supply are separated and far enough from each other, without crossing or intertwining.
- Fit the probe where it is not accessible by the end user.
- In case of applications in industrial environments, the use of mains filters (our mod. FT1) in parallel with inductive loads could be useful.

### 3. General description

The XC640D is designed to manage both compressors and fans in a condensing system such as a pack. The compressors can be scroll or Stream, simple or multistage.

Control is by means of a neutral zone and is based on the pressure or temperature sensed in the LP suction (compressors) and HP (condenser) circuits. A special algorithm balances the run hours of the compressors to distribute the work load uniformly.

The controllers can convert both LP and HP pressures and displays them as temperatures.

The front panel offers complete information on the system's status by displaying the suction and condenser pressure (temperatures), the status of the loads, possible alarms or maintenance conditions.

Each load has its own alarm input that is able to stop it when activated. To guarantee the total system's safety, there are also two inputs for low and high pressure switches: when these are activated, the system is stopped.

By means of the HOT KEY the controller can be easily programmed at power on.

The controller can be connected to the X-WEB, controlling and monitoring system, thanks to the RS485 serial output, using the standard ModBus RTU protocol.

## 4. PROBES RELATED TO THE XC640D

### 4.1 PP07, PP11, PP30 PP50: 4÷20mA pressure transducers

NAME	CABLE LENGTH	RANGE	DIXELL CODE
PP07	2,0MT	-0,5+7bar rel FE	BE009302 00
PP11	2,0MT	-0,5+7bar rel FE	BE009302 07
PP30	2,0MT	0+307bar rel FE	BE009302 04
PP50	2,0MT	0+507bar rel FE	BE009002 05

### 4.2 NP4-67: pipe mounting temperature probe

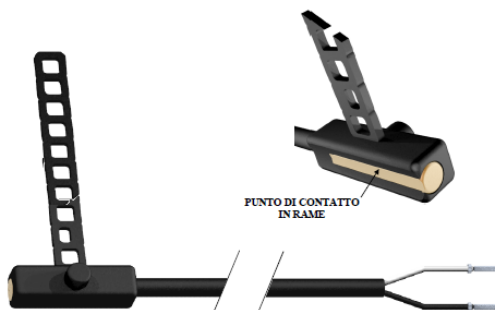

The **NP4-67** temperature probe can be used on the discharge line to monitor the discharge temperature of the Digital Scroll compressor.

**NP4-67** 1.5MT NTC probe  
Measurement range: -40+110°C,  
Cable 1,5mt  
Code BN609001 52

## 5. WIRING & ELECTRICAL CONNECTIONS

### 5.1 General warnings

Before connecting cables make sure the power supply complies with the instrument's requirements.

Separate the probe cables from the power supply cables, from the outputs and the power connections.

**Do not exceed the maximum current allowed on each relay 5A resistive**, in case of heavier loads use a suitable external relay.

### 5.2 Wiring connections

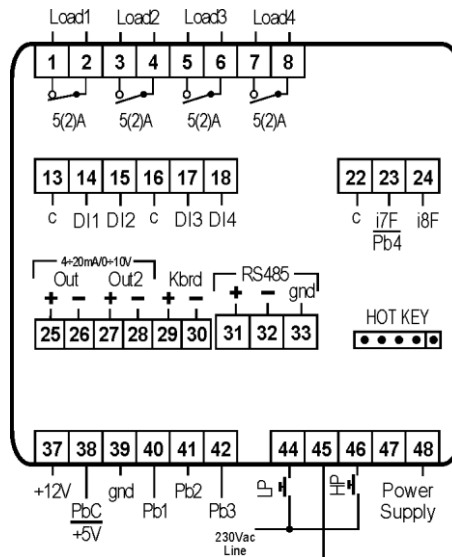

#### NOTE

**120V version:** use terminals 47-48 for power supply; Terminals 44-45-46 operate at 120V

**24V version:** use terminals 47-48 for power supply;

### 5.3 Probes connection

#### 5.3.1 General warnings

**Pressure probe (4 - 20mA or ratiometric):** respect the polarity. If using terminal ends be sure there are no bare parts which could cause short circuiting or introduce noise disturbance at high frequencies. To minimize the induced disturbances use shielded cables with the shield connected to earth.

**Temperature probe:** it is recommended to place the temperature probe away from direct air streams to correctly measure the temperature.



### 5.3.2 Probe wirings

**Low voltage side :** Keep the cables away from the power cables. Use shielded cable to lengthen the cables.

**NOTE1:** The PIN 38 is the common line for the temperature probes

**NOTE2:** The PIN 37 gives a 12Vdc supply for the 4-20mA pressure transducers

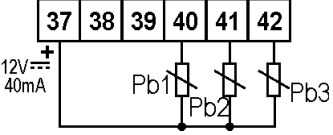
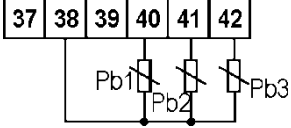
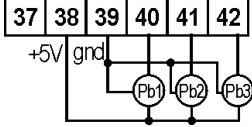
<p><b>PP07 PP11, PP30, PP50 4÷20mA pressure transducers</b> respect the polarity.</p> <p><b>Suction 1 (P1C = Cur)</b> Brown (+) to terminal 37; white (-) to terminal 40</p> <p><b>Condenser (P2C = Cur)</b> Brown (+) to terminal 37; white (-) to terminal 41</p> <p><b>Suction 2 - optional (P3C = Cur)</b> Brown (+) to terminal 37; white (-) to terminal 42</p>	
<p><b>Temperature probes (NTC 10K)</b></p> <p><b>Suction: 38-40 (P1C = NTC)</b></p> <p><b>Condenser: 38-41 (P2C = NTC)</b></p> <p><b>Suction 2 - optional (P3C = NTC): 38-42</b></p> <p><b>Pb4 (P4C = NTC): 38-42</b></p>	
<p><b>Ratiometric transducers (0.5÷4.5Vdc)</b></p> <p><b>Suction 1 (P1C = 0-5)</b> 40 (In); 38(+); 39 (gnd)</p> <p><b>Condenser (P2C =0-5)</b> 41 (In); 38(+); 39 (gnd)</p> <p><b>Suction 2 - optional (P3C = 0-5)</b> 42 (In); 38(+); 39 (gnd)</p>	

## 5.4 LOAD CONNECTIONS

The XC640D is provided with 4 relay, as shown on the picture.  
The relay functionality depends on the setting of the parameters oA1÷oA4.  
According to the features of the loads, suitable external contactors have to be used to supply the loads properly.

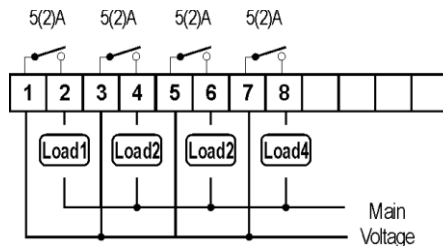

## 5.5 SAFETY AND CONFIGURABLE DIGITAL INPUTS – FREE VOLTAGE

### 5.5.1 Loads safety inputs

Each load has its own safety input, **free voltage**. This input has to collect the status of the safety devices related to the compressor such as thermistors, pressure switches etc.

When this input is activated the correspondence load is switched off and not considered for the regulation.

The correspondence between loads (compressors or fans) and safety inputs is the following

LOAD	TERMINALS	SAFETY INPUT	TERMINALS	CONNECTION
Load 1	1-2	Di1	13-14	
Load 2	3-4	Di2	13-15	
Load 3	5-6	Di3	16-17	
Load 4	7-8	Di4	16-18	

### 5.5.2 Configurable digital inputs.

The controller XC640D is provided with 2 configurable digital inputs, the first one can operate also as probe.

Their functions are set by the parameter iF07 and iF08 respectively.

They can be used for liquid level monitoring, activate the energy saving function or silence mode from a external devices.

The digital input connection is explain in the following table

Digital input	TERMINALS	Related parameter	CONNECTION
First configurable input/Probe 4	22-23 (i1F/Pb4)	iF07: function iP07: polarity	
Second configurable d.i.	22-24 (i2F)	iF08: function iP08: polarity	

## 5.6 Circuit with 1 SUCTION and 1 CONDENSER: HP – LP Pressure switch connections

**!!!WARNING: controller is provided with both free voltage digital inputs, and main voltage inputs.!!!!**

**NOTE:** The main voltage inputs are designed **only** for HP and LP pressure switches.

The **low pressure switch** has to be connected to the terminal 45 (common) and 46 (line)  
The **high pressure switch** has to be connected to the terminal 45 (common) and 44 (line)  
as shown on the following wiring diagram.

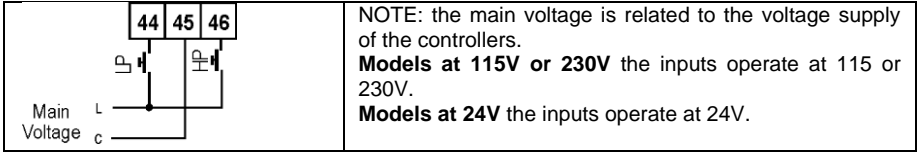

## 5.7 Circuit with 2 SUCTIONS and 1 CONDENSER: HP – LP Pressure switch connections

In case of racks with 2 suction circuits and 1 condenser the LP1, low pressure switch, and HP high pressure switch, must be connected to the terminals 44-45 and 45-46 as explained in the following wiring diagram

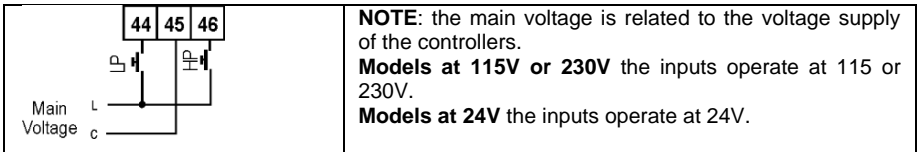

### 5.7.1 Suction 2: connection of the Low Pressure switch.

The **LP2 low pressure switch** of circuit 2, **must be a free of voltage** signal.

To manage it, set:

**i8F = LP2** and then connect it to the terminals 22-24.

## 5.8 Analog output connection

The controller supply up to 2 analog outputs, terminals, kind of output and functionality are shown in the following table

	Terminals	Related parameter
Analog output 1	25[+] – 26[-].	<b>AOC:</b> Kind of signal (4-20mA/0-10V) <b>AOF:</b> function
Analog output 2	27[+] – 28[-].	<b>2AOC:</b> Kind of signal (4-20mA/0-10V) <b>2AOF:</b> function

## 5.9 How to connect monitoring system - RS485 Serial line

The **Adr** parameter is the number to identify each electronic board. **Address duplication is not permitted**, in this case the communication with monitoring system is not guaranteed (the **Adr** is also the ModBUS address).

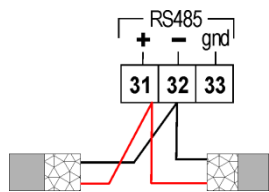

- 1) Terminals [31] [+] and [32] [-].
- 2) Use shielded twisted cable. For example Belden® 8762 or 8772 or cat 5 cables.
- 3) Maximum distance 1Km.
- 4) Don't connect the shield to the earth or to GND terminals of the device, avoid accidental contacts by using insulating tape.

## 6. Mounting & installation

The instruments are suitable only for internal use.

Instrument **XC640D** shall be mounted on an omega DIN rail

The ambient operating temperature range is between -10÷60°C.

Avoid locations subject to heavy vibration, corrosive gases or excessive dirt. The same applies to the probes. Ensure ventilation around the instrument.

## 7. First installation

At first installation, it's necessary the following:

1. **Select the kind of gas.**
2. **Set the range of the pressure probes.**

In the following paragraph a short cut for the above operations.

Chapters 11 Parameters programming and 0 will show in detail these operations.

### 7.1 How to set the kind of gas

The kind of gas is set by the parameter FtyP.

The controller has memorized the relation between temperature and pressure for some gases.

**The pre-set gas is: r404. (FtyP=404)**

If another gas is used, act as in the following:

1. Enter the Programming mode by pressing the **Set** and **DOWN** key for 3s.
2. Select the "**Pr2**" parameter. Then enter the password **3 2 1 0**.
3. Select the **FtyP, kind of gas**, parameter.
4. Press the "**SET**" key: the value of the parameter will start blinking.
5. Use "**UP**" or "**DOWN**" to change the gas among the following: **r22= R22; r404=R404A; -407A = r407A; 407C= r407C; 407F= r407F; 410= r410; 507=R507; 134=134; 134= r134; CO2= CO2**. Press "**SET**" to store the new value and move to the following parameter.

**To exit: Press SET + UP or wait 30s without pressing a key.**

**NOTE:** the set value is stored even when the procedure is exited by waiting the time-out to expire.

## 7.2 How to set the range of the pressure probes

If an instrument with the following part number is used: XC640D – xxxxF, it is pre-set to work with pressure probe with the following range:

Suction Probe :  $-0.5 \div 11.0$  bar (relative pressure);

Discharge Probe :  $0 \div 30.0$  bar (relative pressure)

If the probes you're using have a different range act as in the following:

To set the pressure range of the **Probe 1 (suction probe)** use the parameter:

**PA04: Adjustment of read out corresponding to 4mA (0.5V)**

**PA20: Adjustment of read out corresponding to 20mA (4.5V)**

To set the pressure range of the **Probe 2 (Condenser probe)** use the parameter:

**FA04: Adjustment of read out corresponding to 4mA (0.5V)**

**FA20: Adjustment of read out corresponding to 20mA (4.5V)**

Practically these parameters have to be set with the start and end scale of the probe range.

### How to do:

1. Enter the Programming mode by pressing the **Set** and **DOWN** key for 3s.
2. Select the "**Pr2**" parameter. Then enter the password 3 2 1 0.
3. Select the **PA04, adjustment of read out corresponding to 4mA (0.5V)**, parameter.
4. Press the "**SET**" key: the value of the parameter will start blinking.
5. Set the lower value of the probe range.
6. Push the **SET** key to confirm the value. The **PA20: adjustment of read out corresponding to 20mA (4.5V)** parameter will be displayed.
7. Set the higher value of the range.
8. Push the **SET** key to confirm the value. Next parameter will be displayed.

Do the same things for the Probe 2, **FA04**, **FA20** parameters.

## 8. User interface

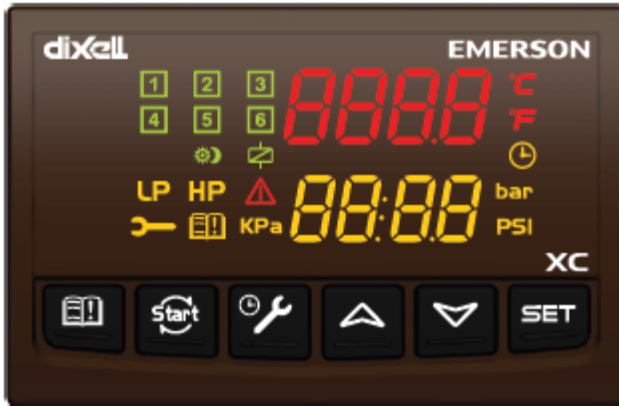

### 8.1 Displaying

UPPER DISPLAY	LOWER DISPLAY	ICONS
Suction temperature or pressure	Discharge temperature or pressure	- Working loads - Measurement unit - Alarm or status Icons

### 8.2 Keyboard

#### SET (SET)

**Standard visualization:** to see or modify the set point. In programming mode it selects a parameter or confirms an operation.

**Alarm menu:** By holding it pressed for **3s**, the current alarm is erased.

#### ^ (UP).

**In programming mode:** it browses the parameter codes or increases the displayed value.

**With Hot key inserted:** it starts the Hot key programming procedure.

**To access the INFO menu:** push and release it to access the INFO menu.

#### ▼ (DOWN)

**In programming mode:** it browses the parameter codes or decreases the displayed value.



**Manual restart of loads:** By holding it pressed for **3s**, it switches on again loads previous locked by a safety digital input alarm.



**MAINTENANCE/CLOCK:** To display the loads running hours  
By holding it pressed for 3s the **Maintaining menu** is entered



**To enter the Alarm menu**





















## KEY COMBINATIONS

**▲ + ▼** To lock and unlock the keyboard.

**SET + ▼** To enter the programming mode.

**SET + ▲** To exit the programming mode.

## 8.3 Icons

LED	FUNCTION	MEANING
	ON	Celsius degrees
	ON	Fahrenheit degrees
	ON	bar displaying
	ON	PSI displaying
	ON	KPA displaying
	ON	Load 1 on
	Flashing	Load 1 is waiting to start (1HZ) or digital input alarm for Load 1 (2Hz). or Load 1 in maintenance status (2Hz).
	ON	Load 2 on
	Flashing	Load 2 is waiting to start (1HZ). or digital input alarm for Load 2 (2Hz). o Load 2 in maintenance status (2Hz).
	ON	Load 3 on
	Flashing	Load 3 is waiting to start (1HZ). or digital input alarm for Load 3 (2Hz). o Load 3 in maintenance status (2Hz).
	ON	Load 4 on
	Flashing	Load 4 is waiting to start (1HZ). or digital input alarm for Load 4 (2Hz). o Load 4 in maintenance status (2Hz).
	ON	The Maintenance menu has been entered
	Flashing	One or more loads have been placed in maintenance status
	ON	Low pressure switch alarm
	ON	High pressure switch alarm
	ON	Alarm is happening
	ON	All the stored alarms have been seen.
	Flashing	A new alarm has happened
	ON	Energy saving activated

## 9. How to see and modify the set point(s)

### 9.1 How to see the set point of compressors and/or fans

If the controller is managing both compressors and fans, both the set points are displayed in sequence, otherwise only the set point of the enabled section will be displayed.

- 1) Push and release the **SET** key;
- 2) The Lower display will show the “**SEtC**” label, while the Upper display will show its value.
- 3) If second suction is configured, by pushing again the **SET** key the Lower display will show the “**StC2**” label, while the Upper display will show its value
- 4) To see the fan set point, push again the **SET** key.
- 5) The Lower display will show the “**SEtF**” label, while the Upper display will show the fan set point.

**To exit:** push the **SET** key or wait for 30 without pressing any keys.

## 9.2 How to modify the set point of compressors and/or fans

**\*\*\*\*\*WARNING: before setting the target set points for the first time, check and, if necessary, modify the type of refrigerant gas (par. FtyP) and the default unit of measurement (par. dEU) for compressors and fans \*\*\*\*\***

### PRE-ACTION

1. **Set the kind of refrigerant by means of the FtyP parameter (see 7.1 How to set the kind of gas)**
2. **Set the measurement unit (dEU par.).**
3. **Check and if necessary modify the set point limits (LSE and HSE par.).**

### PROCEDURE

1. Push the **SET** key for more than 2 seconds;
2. The Lower display will show the “**SEtC1**” label, will the Upper display will show its value flashing.
3. To change the suction set point value, push the ▲ or ▼ within 30s.
4. To memorize the new value and pass to the fan set point, push the **SET** key.
5. If the second circuit is enabled the Lower display will show the “**SEtC2**” label, will the Upper display will show its value flashing.
6. To change the suction set point value, push the ▲ or ▼ within 30s.
7. To memorize the new value and pass to the fan set point, push the **SET** key.
8. The Lower display will show the “**SEtF**” label, will the Upper display will show the fan set point flashing.
9. To change its value, push the ▲ or ▼ within 30s.

**To exit:** push the **SET** key or wait for 30 without pressing any keys.



## 10. The INFO menu

The controller can display some information directly from the main menu. The INFO menu is accessible by pushing and releasing the **UP** key:

Here below the list of the information that can be displayed:

**NOTE: this information is displayed only if the related function is enabled**

- **P1t:** temperature value of the P1 probe
- **P1P:** pressure value of the P1 probe
- **P2t:** temperature value of the P2 probe
- **P2P:** pressure value of the P2 probe (if P2 present)
- **P3t:** temperature value of the P3 probe (if P3 present)
- **P3P:** pressure value of the P3 probe (if P3 present)
- **P4t:** temperature value of the P4 probe (if P4 present)
- **LinJ:** status of the injection output (“On” – “OFF”), This information is available only if one relay, oA2 ÷ oA4 is set as “Lin”.
- **SEtd:** value of the **Dynamic Set point**.  
This information is available only if the Dynamic set point function is enabled (par. dSEP ≠ nP)
- **AO1** Percentage of the analog output 1 (4-20mA or 0-10V).
- This information is always available
- **AO2:** Percentage of the analog output 2 (4-20mA or 0-10V).
- This information is always available
- **SSC1: Supervising Set for circuit 1**, if supervising system is sending the set point to the controller
- **SSC2: Supervising Set for circuit 2**, if supervising system is sending the set point to the controller
- **SStF: Supervising Set for fan**, if supervising system is sending the set point to the controller

**EXIT:** push the **SET+UP** keys together.

## 11. Parameters programming

### 11.1 How to enter the “Pr1” parameter list

To enter the “Pr1” parameter list, user accessible, operate as follows:

1. Hold pressed the **SET** and **DOWN** key for 3s.
2. The controller displays the name of the parameter in the Lower display, its value on the Upper display.
3. Press the **“SET”** key: the value of the parameter will start blinking.
4. Use **“UP”** or **“DOWN”** to change the value.
5. Press **“SET”** to store the new value and move to the following parameter.

**To exit:** Press **SET + UP** or wait 30s without pressing a key.

**NOTE:** the set value is stored even when the procedure is exited by waiting the time-out to expire.

## 11.2 How to enter in parameters list “Pr2”

The “Pr2” parameter list is protected by a security code (Password).

**SECURITY CODE is            3210**

To access parameters in “Pr2”:

1. Enter the “Pr1” level.
2. Select “Pr2” parameter and press the “**SET**” key.
3. The flashing value “0 ---” is displayed.
4. Use **▲** or **▼** to input the security code and confirm the figure by pressing “**SET**” key.
5. Repeat operations 2 and 3 for the other digits.

**NOTE:** each parameter in “Pr2” can be removed or put into “Pr1” (user level) by pressing “**SET**” + **▼**. When a parameter is present also in “Pr1” decimal point of the lower display is on.

## 11.3 How to change parameter values

1. Enter the Programming mode.
2. Select the required parameter with **▲** or **▼**.
3. Press the “**SET**” key the value start blinking.
4. Use **▲** or **▼** to change its value.
5. Press “**SET**” to store the new value and move to the following parameter.

**To exit:** Press **SET + UP** or wait 15s without pressing a key.

**NOTE:** the new programming is stored even when the procedure is exited by waiting the time-out.

## 12. How to disabled an output

To disabled an output during a maintenance session means to exclude the output from the regulation.

### 12.1 How to disabled an output during a maintenance session.

1. Push the **MAINTENANCE/CLOCK** () key for 3s.
2. The LED's of the first output is switched on, the Lower display shows the “**StA**” label, while the Upper display shows the “**On**” label if the first output is enabled, or the “**oFF**” label if the output is disabled for a maintenance section.  
With compressor with more steps all the LED's linked to the compressor and the valves are switched on..
3. Select the output by pressing the **UP** or **DOWN** key.
4. **To modify the status of the output:** push the **SET** key, the status of the output starts flashing, then push the UP or DOWN to pass from “**On**” to “**oFF**” and vice versa.
5. Push the **SET** key to confirm the status and pass to the next output..

**To exit:** push the **CLOCK** key or wait 30 sec

### 12.2 Output disabled signaling.

If an output is disabled its led blinks (2 Hz)

### 12.3 Regulation with some outputs disabled.

If some outputs are disabled they don't take part to the regulation, so the regulation goes on with the other outputs.

## 13. Running hours of loads

### 13.1 How to display the running hours of a load.

The controller memorizes the running hours of each load.

To see how long a load has been working follow this procedure:

1. Press and release the “**MAINTENANCE/CLOCK** ()” key.
2. The LED of the first output is switched on, the Upper Display shows the “**HUR**” label, while the Lower Display shows the shows the running hours of the first output.
3. To see the running hours of the following load press the UP key .

**To exit:** push the  key or wait 30 sec

### 13.2 How to reset the running hours of a load.

1. Display the running hour according to the above procedure.
2. Select the load by pressing the UP key.
3. Push the **SET** key (immediately on the lower display the **rSt** label is displayed).

4. Hold pushed the key for some seconds till the “rSt” label starts flashing and the lower display shows zero.

**To exit:** push the **CLOCK** key or wait 30 sec

**NOTE:** if the **SET** key is released within 2s, the controller reverts to display the running hours of the selected loads..

## 14. Alarm Menu

The controller memorizes the last 20 alarms happened, together with their duration..  
To see the alarm codes see par. **par. 22.**

### 14.1 How to see the alarms

1. Push the  **Alarm** key.
2. The last alarm happened is showed on the Upper display, while the lower display shows its number.
3. Push again the **▲** key and the other alarm are displayed starting from the most recent.
4. To see the alarm **duration** and push the **SET** key.
5. By pushing again the **▲** **or SET** key the next alarm is displayed.

#### Alarms erasing.

1. Enter the Alarm Menu.
2. To erase the displayed alarm push the “**SET**” key till the “rSt” label will be displayed in the Lower Display,  
**NOTE** the running alarms cannot be erased..
3. To erase the whole Alarm Menu, hold pressed the “**SET**” key for 10s.

## 15. Keyboard locking

### 15.1 How to lock the keyboard

1. Keep the **▲** and **▼** keys pressed together for more than 3 s the **▲** and **▼** keys.
2. The “POF” message will be displayed and the keyboard is locked. At this point it is only possible to view the set point or enter the HACCP menu.

### 15.2 To unlock the keyboard

Keep the **▲** and **▼** keys pressed together for more than 3s till the “**POn**” flashing message appears.

## 16. Use of the programming “HOT KEY “

### 16.1 How to program a hot key from the instrument (UPLOAD)

1. Program one controller with the front keypad.
2. When the controller is ON, insert the “**Hot key**” and push **▲** key; the “**uPL**” message appears followed a by flashing “**End**”
3. Push “**SET**” key and the **End** will stop flashing.
4. Turn OFF the instrument remove the “**Hot Key**”, then turn it ON again.

**NOTE:** the “**Err**” message is displayed for failed programming. In this case push again **▲** key if you want to restart the upload again or remove the “**Hot key**” to abort the operation.

### 16.2 How to program an instrument using a hot key (DOWNLOAD)

1. Turn OFF the instrument.
2. Insert a **programmed “Hot Key” into the 5 PIN receptacle** and then turn the Controller ON.
3. Automatically the parameter list of the “**Hot Key**” is downloaded into the Controller memory, the “**doL**” message is blinking followed a by flashing “**End**”.
4. After 10 seconds the instrument will restart working with the new parameters.
5. Remove the “**Hot Key**”..

**NOTE** the message “**Err**” is displayed for failed programming. In this case turn the unit off and then on if you want to restart the download again or remove the “**Hot key**” to abort the operation.

The unit can UPLOAD or DOWNLOAD the parameter list from its own E2 internal memory to the “**Hot Key**” and vice-versa.

## 17. List of parameters

### 17.1 Plant dimensioning and type of regulation.

The XC640D is pre-set to drive a rack with 3 compressors and 3 fans.

**oA1 (term. 1-2), oA2 (term. 3-4), oA3 (term. 5-6), oA4 (term. 7-8), relay 1, 2, 3, 4, configuration:** by means of these parameters the plant can be dimensioned according to the number and type of compressors and/or fans and the number of steps for each one.

Each relay according to the configuration of the oA(i) parameter can work as:

- **Not used**= nu
- **Compressor circuit1:** oAi = cPr1,
- **Compressor circuit2:** oAi = cPr2,
- **Step:** oAi = StP
- **Inverter compressor for circuit 1** = inC1
- **Inverter compressor for circuit 2** = inC2
- **Fan:** oAi = FAn
- **Fan with inverter/ECI fan:** oAi = InF
- **Injection of cooling liquid:** oAi = Lin
- **Alarm:** oAi = ALr

**NOTE:** also the “dGS”, “6dG”, “dGst” values are present. These values **must not** be used.

#### COMPRESSORS CONFIGURATION

According to the oA1, oA2, oA3, oA4, oA5, oA6 configuration, 2 kinds of plant can be defined:

**Rack with compressors only:** all the oAi different from FAn

**Rack with compressors and fans:** both FAn and CPr are used for oAi.

**NOTE: CONFIGURATION OF COMPRESSOR WITH UNLOADERS (STEPS):** the output of compressor has to be set before the output for unloaders (steps).

**ES.** Compressor with 1 unloader: **oA1 = cPr, oA2= StP.**

If compressor with different capacities are used (**CtyP=dPo**), all the oAi must to be configured as **cPr** (compressor) otherwise the **configuration alarm “CStP” will be activated.**

If compressors with **different capacities** are used (**CtyP=dPo**), all the oAi must to be configured as **cPr** (compressor) otherwise the **configuration alarm “CStP” will be activated.**

**If an oAi set as step without any previous oAi set as cPr the configuration alarm “CStP” will be activated.**

#### PLANT CONFIGURATION EXAMPLES:

**Plant with 3 compressors 3 fans default configuration with PP11, PP30 pressure transducers:**

oA1 = CPr1,  
oA2 = CPr1,  
oA3 = FAn,  
oA4 = FAn,

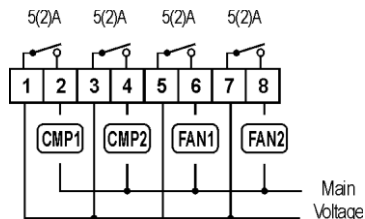

**Plant with 4 compressors**

**without fans:**

- oA1 = CPr1,
- oA2 = CPr1,
- oA3 = CPr1,
- oA4 = CPr1,

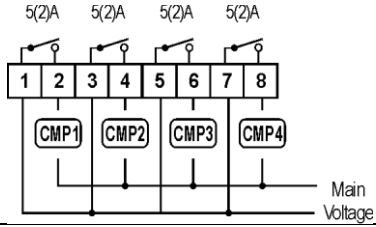

**Plant with 1 frequency compressor + 2 standard compressors and inverter for fans:**

- oA1 = InC1,
- oA2 = CPr1,
- oA3 = CPr1,
- oA4 = inF,
- AOC = tEn**
- AOF = InC1**
- 2AOC = tEn**
- 2AOF = inF**

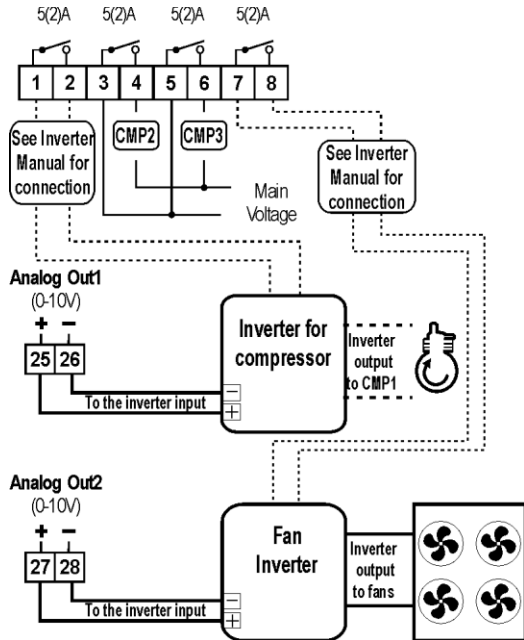

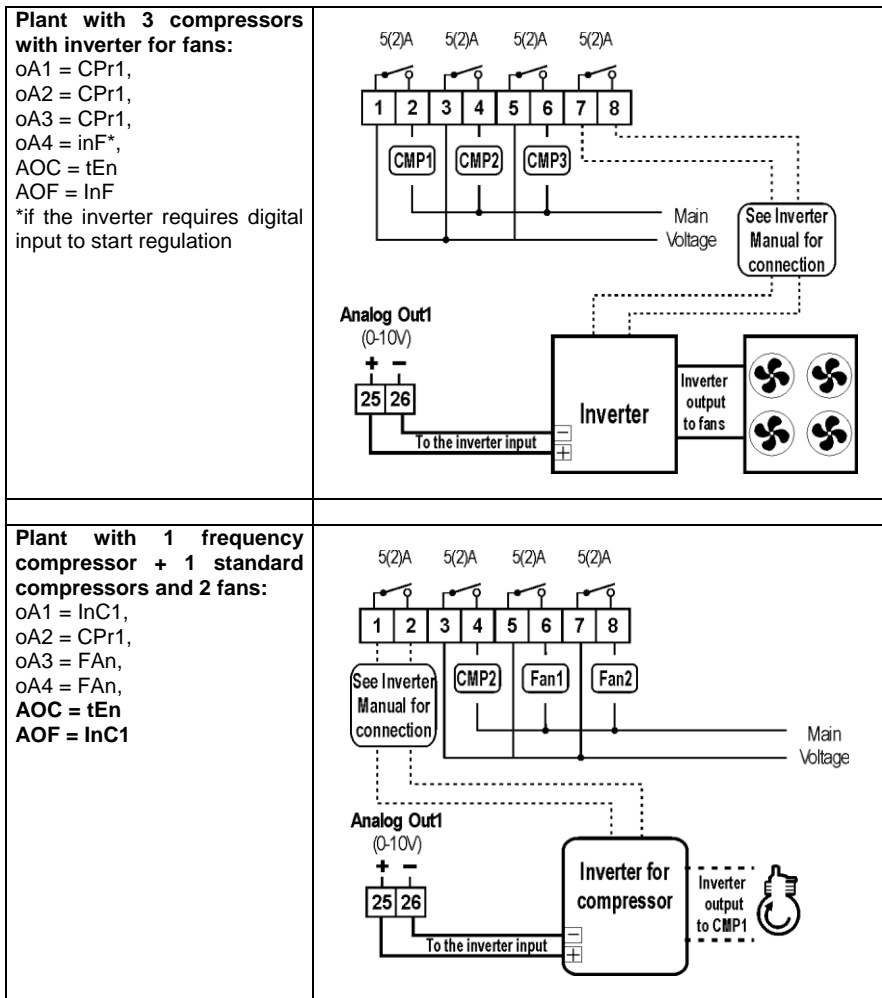

- CtyP** **Compressor type:** it sets if compressors have the same power (homogeneous) or not.  
**SPO = compressors with same capacity**  
**dPo = compressor with different capacities.**  
**Scr = screw compressors.**
- StP** **Valve outputs (unloader) polarity:** polarity of the outputs for capacity valves. It determines the status of the relays associated with the capacity valves (only for homogeneous and stepped-capacity compressors)  
**oP=**valve activated with open contacts of the relay;  
**cL=** valve activated with close contacts of the relay.
- PC1..PC4** **Capacity of compressor 1...4:** for setting the capacity of single compressors. It's used only if CtyP=dPo.  
Insert in each parameter the capacity of the compressor used.  
**E.I.** 3 compressors with following capacity: 10, 20, 40 HP. The parameters have to be set in this way: PC1=10, PC2=20, PC3=40.



**FtyP:** **Freon Type:** set the kind of freon used in the plant : **r22=** R22; **r404=R404A**; - **407A** = r407A; **407C=** r407C; **407F=** r407F; **410=** r410A; **507=R507**; **134=** r134; **CO2=** CO2 (carbon dioxide).

**Sty** **Compressors rotation enabling**

**YES = rotation enabled** : this algorithm distributes the working time between the various compressors to ensure even run times.

**no = fixed sequence:** the compressors are enabled and disabled in fixed sequence: first, second etc.

**NOTE:** If a relay is set as **inverter** is always started as first and switched off as last. In any case, if it is locked because of safety timers, it can be started to maintain the pressure in the regulation band.

**rot** **Fan rotation enabling**

**YES = rotation enabled:** this algorithm distributes the working time between the various fans to ensure even run times.

**no = fixed sequence:** the fans are enabled and disabled in fixed sequence: first, second etc.

## 17.2 Probes configuration

Probes can be used in different ways according to plant features, as described in the following table:

### 17.2.1 Suction probe configuration

**P1c:** **Suction probe setting (probe 1):**

**nP** = not used: don't set it;

**Cur** = 4 ÷ 20 mA pressure transducer; use term. 37(+), 40 (in); 39 (gnd) if present

**tEn** = 0.5÷4.5V ratiometric pressure transducer; use term. **38(+)**, 40 (in); 39 (gnd)

**ntc** = NTC 10K probe; use term. 38-40

**PA04:** **Adjustment of read out for the Probe 1** (used only if P1c=Cur or tEn). Corresponding to **4mA or 0.5V** input signal, given by the suction probe (-1.0 ÷ PA20bar; -15÷PA20PSI; -100 ÷ PA20KPA)

**E.I. PP11** relative pressure transducer, range -0.5÷11.0 bar. PA04=-0.5; PA20=11.0

**PP30** relative pressure transducer, range: 0÷30bar. PA04=0.0; PA20=30.0.

**PA20:** **Adjustment of read out for the Probe 1** corresponding to **20mA or 4.5V** input signal, given by the suction probe (PA04 ÷ 51.0BAR; PA04 ÷ 750PSI; PA04 ÷ 5100KPA).

**CAL:** **Probe 1 calibration:** the range depends on the dEU parameter:

dEU=bar or °C: -12.0÷12.0;

dEU=PSI or °F: -200÷200;

dEU=kPA: -999÷999;

### 17.2.2 Condenser probe configuration

**P2c:** **Condenser probe setting (probe 2):**

**nP** = not used:

**Cur** = 4 ÷ 20 mA pressure transducer; use term. 37(+), 41 (in); 39 (gnd) if present

**tEn** = 0.5÷4.5V ratiometric pressure transducer; use term. **38(+)**, 41 (in); 39 (gnd)

**ntc** = NTC 10K probe; use term. 38- 41

**FA04:** **Adjustment of read out for the Probe 2** (used only if P2c=Cur or tEn). corresponding to **4mA or 0.5V** input signal, given by the delivery probe (-1.0 ÷ FA20bar; -15÷FA20PSI; -100 ÷ FA20KPA)

**FA20:** **Adjustment of read out for the Probe 2** corresponding to **20mA or 4.5V** input signal, given by the condensing probe (FA04 ÷ 51.0BAR; FA04 ÷ 750PSI; FA04 ÷ 5100KPA)

**FCAL:** **Probe 2 calibration** the range depends on the dEU parameter:

dEU=bar or °C: -12.0÷12.0;

dEU=PSI or °F: -200÷200;

dEU=kPA: -999÷999;

### **17.2.3 Probe 3 configuration**

**P3c: Probe 3 setting:**

nP = not used:

Cur = 4 ÷ 20 mA pressure transducer; use term. 37(+), 42 (in); 39 (gnd) if present

tEn = 0.5÷4.5V ratiometric pressure transducer; use term. 38(+), 42 (in); 39 (gnd)

nt10 = NTC 10K 38-42

nt86 = NTC 86K 38-42

**3P04: Adjustment of read out for the Probe 3** (used only if P3c=Cur or tEn). corresponding to **4mA or 0.5V** input signal, given by the delivery probe (-1.0 ÷ FA20bar; -15÷FA20PSI; -100 ÷ FA20KPA)

**3P20: Adjustment of read out for the Probe 3** corresponding to **20mA or 4.5V** input signal, given by the condensing probe (FA04 ÷ 51.0BAR; FA04 ÷ 750PSI; FA04 ÷ 5100KPA)

**O3: Probe 3 calibration** the range depends on the dEU parameter:

dEU=bar or °C: -12.0÷12.0;

dEU=PSI or °F: -200÷200;

dEU=kPA: -999÷999;

### **17.2.4 Probe 4 configuration**

**P4c: Probe 4 setting (22-23):**

nP = not used:

nt10 = NTC 10K

nt86 = NTC 86K

**O4: Probe 4 calibration** the range depends on the dEU parameter:

dEU= °C: -12.0÷12.0;

dEU= °F: -200÷200;

### **17.2.5 Probe selection second suction circuit**

**2CPb: Probe selection for second suction circuit**

nP = not used:

P1 = Probe 1 – **NOT SET IT**: already used for first suction circuit

P2 = Probe 2 – **NOT SET IT** : already used for fan

P3 = Probe 3 – **SET this probe!**

### **17.2.6 Probe selection for fan**

**FPb: Probe selection for condenser fan**

nP = not used:

P1 = Probe 1

P2 = Probe 2

P3 = Probe 3

## **17.3 Configurable digital inputs configuration**

**iF07 Configurable digital input i1F function** (terminals 22-23):

**NB: THE FOLLOWING FUNCTIONALITIES ARE ENABLED ONLY WHEN P4C=NP**

**nu = Not used:** the digital input is disabled.

**inF** = Safety digital input of inverter for fan, used when none relay is configured as inverter for fans

**ES** = Energy saving;

**oFF** = instrument shut down;

**LL** = liquid level alarm

**SIL** = to enable the silence function

**EAL** = generic external alarm, it doesn't affect the regulation

**NOTE:** also the following values: "OA1", "OA2", "OA3", "OA4", "OA5", "OA6", "LP1", "LP2", "HP" are present. These values **must not** be used..

**iF08 Configurable digital input i2F function** (terminals 22-24):

**nu = Not used:** the digital input is disabled.

**inF =** Safety digital input of inverter for fan, used when none relay is configured as inverter for fans

**ES =** Energy saving;

**oFF =** instrument shut down;

**LL =** liquid level alarm

**SIL =** to enable the silence function

**EAL =** generic external alarm, it doesn't affect the regulation

**NOTE:** also the following values: "OA1", "OA2", "OA3", "OA4", "OA5", "OA6", "LP1", "LP2", "HP" are present. These values **must not** be used..

**iP01 Safety input for Load 1 polarity (13-14):**

**oP:** the digital input is activated by opening the contact;

**CL:** the digital input is activated by closing the contact.

**iP02 Safety input for Load 2 polarity (13-15):**

**oP:** the digital input is activated by opening the contact;

**CL:** the digital input is activated by closing the contact.

**iP03 Safety input for Load 3 polarity (16-17):**

**oP:** the digital input is activated by opening the contact;

**CL:** the digital input is activated by closing the contact.

**iP04 Safety input for Load 4 polarity (16-18):**

**oP:** the digital input is activated by opening the contact;

**CL:** the digital input is activated by closing the contact.

**iP07 Configurable digital input i1F polarity (22-23):**

**oP:** the digital input is activated by opening the contact;

**CL:** the digital input is activated by closing the contact.

**iP08 Configurable digital input i2F polarity (22-24)**

**oP:** the digital input is activated by opening the contact;

**CL:** the digital input is activated by closing the contact.

**iP09: Polarity of High pressure-switch alarm** (terminals 45-46)

**oP =**HP alarm is signaled without voltage presence

**cL=** HP alarm is signaled with voltage presence

**iP10: Polarity of Low pressure-switch alarm** (terminals 44-45)

**oP =**LP alarm is signaled without voltage presence

**cL=** LP alarm is signaled with voltage presence

**did** **Liquid level alarm, signaling delay:** (enabled only if iF07 or iF08=LL) 0÷255min

**didA** **External alarm, signaling delay:** (enabled only if iF07 or iF08=EAL) 0÷255min

**ALMr** **Manual reset of alarms for compressors and fans.**

**no =** automatic recover of alarm: regulation restart when the correspondent digital input is disabled; **yES =** manual recover for the alarms of compressors and fans See also par.22.1.2

## 17.4 Display and Measurement unit

The measurement unit of the parameters referred to temperature or pressure depends on the parameters dEU, CF and PMu.

**NOTE:** The controller automatically converts values of set points and parameters referred to the pressure/temperature when the dEU parameter is changed. In any case check the value of the parameters referred to temperature and pressure after changing dEU.

**dEU: Selection of the kind of measurement unit: pressure or temperature**

**dEU = tMP:** the parameters referred to pressure/temperature will be expressed in temperature according to the value of the CF parameter (°C or °F)

- dEU = PrS:** the parameters referred to pressure/temperature will be expressed in pressure according to the value of the PMU parameter (bar, PSI or KPA)
- CF Measurement unit for temperature:** it is used only with dEU = tMP, and it set the measurement unit for parameters referred to temperature/pressure.  
**°C** = Celsius degree  
**°F** = Fahrenheit degree
- PMU Measurement unit for pressure:** it is used only with dEU = PrS, and it set the measurement unit for parameters referred to temperature/pressure.  
**bar** = bar  
**PSI** = PSI  
**PA** = kPA
- rES Resolution for °C and bar (in = integer; dE= decimal point)**
- dEU1 Default visualization for upper display: PrS=** Pressure; **tPr=** temperature
- dSP2 Probe selection for lower display: nu** = display switched off - **P1** = Probe 1 - **P2** = Probe 2 - **P3** = Probe 3 - **P4** = Probe 4 - **StC1** = Compressor Set Point - **StC2** = Compressor set point for section 2 – **SetF** = Fan set point
- dEU2 Default visualization for lower display: tPr=** temperature, **PrS=** Pressure;

## 17.5 Compressor regulation

- Pbd Proportional band or neutral zone width** (0.1÷5.0bar/0.5÷30°C or 1÷150PSI/1÷50°F)  
 The band (or zone) is symmetrical compared to the target set point, with extremes: set-Pbd/2 ÷ set+Pbd/2. It is used as proportional band for PI algorithm.  
 The measurement unit depends on the dEU, CF, PMU par.
- rS Proportional band offset:** PI band offset. It permits to move the proportional band of the PI. With **rS=0** the band is between Set-Pbd/2 ÷ Set+Pbd/2;
- inC Integration time:** (0 ÷ 999s) PI integration time
- ton Inverter at maximum capacity before starting a new load** (0÷255s)
- toF Inverter at minimum capacity before stopping a load** (0÷255s)
- ESC Energy saving value for compressors:** (-20÷20bar; -50÷50°C) this value is add to the compressor set point.
- onon: Minimum time between 2 following switching ON of the same compressor** (0÷255 min).
- oFon: Minimum time between the switching off of a compressor and the following switching on.** (0÷255min). *Note: usually onon is greater than oFon.*
- don: Time delay between the insertion of two different compressors** (0÷99.5min; res. 10s).
- doF: Time delay between switching off of two different compressors** (0÷99.5 min; res. 10s)
- donF: Minimum time a stage stays switched ON** (0÷99.5 min; res. 10s)
- Maon Maximum time for compressor ON** (0 ÷ 24 h; with 0 this function is disabled.) If a compressor keeps staying on for the MAon time, it's switched off and it can restart after the oFon standard time.
- FdLy: "don" delay enabled also for the first call.** If enabled, the triggering of the step is delayed for a "don" value, respect to the call. (**no** = "don" not enabled; **yES**="don" enabled)
- FdLF "doF" delay enabled also for the first switching off.** It enables the "doF" delay between the request of a release and the actual switching off. (**no** = "doF" not enabled; **yES**="doF" enabled)
- odo: Regulation delay on start-up:** (0÷255s) on switching ON the instrument starts working after the time delay imposed in this parameter.
- LSE: Minimum set point:** The measurement unit depends on dEU parameter. It sets the minimum value that can be used for the set point, to prevent the end user from setting incorrect values.

**HSE: Maximum set point:** The measurement unit depends on dEU parameter. It sets the maximum acceptable value for set point.

## 17.6 Liquid injection thermostat

- Lit:** **Set point ( °C) for cooling injection thermostat** (0 ÷ 150°C) The reference probe is set by LiPr parameter, the thermostat relay is given by the relay set as **oAi = Lin**.
- Lid:** **Differential for cooling injection thermostat** (0.1 ÷ 10.0) The reference probe is set by LiPr parameter
- LiPr** **Probe for cooling injection thermostat:**  
**nP:** function disabled  
**P3:** probe P3 (term. 38-42)  
**P4:** probe P4 (term. 22-23)

## 17.7 Fans regulation

- Pb** **Proportional band zone width** (0.1÷30.0°C; 1÷50°F; 0.1÷10.0bar, 1÷150PSI; 10÷1000KPA).  
**NOTE: Set the dEU par. and the target set point for fans before setting this parameter.**  
The band is symmetrical compared to the target set point, with extremes: SETF+Pb/2 ÷ SETF -Pb/2. The measurement unit depends on the dEU par.
- ESF** **Energy saving value for fans:** (-20÷20bar; -50÷50°C) this value is add to the fans set point.
- PbES** **Band offset for fan regulation in ES** (-50.0÷50.0°C; -90÷90°F; -20.0÷20.0bar; -300÷300PSI; -2000÷2000KPA). During energy saving
- Fon** **Time delay between the insertion of two different fans** (0÷255sec).
- FoF** **Time delay between switching off of two different compressors** (0÷255 sec)
- LSF** **Minimum set point for fan:** The measurement unit depends on dEU parameter. It sets the minimum value that can be used for the set point, to prevent the end user from setting incorrect values.
- HSF** **Maximum set point for fan:** The measurement unit depends on dEU parameter. It sets the maximum acceptable value for set point.

## 17.8 Alarms – compressor section

- PAo:** **Alarm probe exclusion at power on.** it is the period starting from instrument switch on, before an alarm probe is signaled. (0÷255 min). During this time if the pressure is out of range all the compressor are switched on.
- LAL:** **Low pressure (temperature) alarm – compressor section:** The measurement unit depends on dEU parameter: (PA04 ÷ HAL bar; -50.0÷HAL °C; PA04÷HAL PSI; -58÷HAL °F) It's **independent** from the set point. When the value **LAL** is reached the A03C alarm is enabled, (possibly after the **tAo** delay time).
- HAL:** **High pressure (temperature) alarm– compressor section:** The measurement unit depends on dEU parameter: (LAL ÷ PA20 bar; LAL÷150.0 °C; LAL÷PA20 PSI; LAL÷302 °F). It's **independent** from the set point. When the value **HAL** is reached the A04C alarm is enabled, (possibly after the **tAo** delay time).
- tAo:** **Low and High pressure (temperature) alarms delay– compressor section:** (0÷255 min) time interval between the detection of a pressure (temperature) alarm condition and alarm signaling.
- ELP** **Electronic pressure switch threshold:** (-50°C÷STC1; -58°F÷STC1; PA04÷STC1); Pressure / Temperature value at which all the compressors are switched off. It has to be set some degrees above the mechanical low pressure switch value, in order to prevent mechanical low pressure activation.

- SEr:** **Service request:** (1÷999 hours, res. 10h; 0 = alarm excluded ) number of running hours after that the "A14" maintenance call is generated.
- PEn:** **Low pressure-switch intervention numbers:** (0÷15). If the low pressure-switch is enabled PEn times in the PEI interval, the controller is locked. **Only the manually unlocking is possible.** See also the alarms table at paragraph 22. Every time the pressure-switch is enabled all the compressor are turned off.
- PEI:** **Pressure-switch interventions time** (0÷255 min) Interval, linked to the Pen parameter, for counting interventions of the low pressure-switch..
- SPr:** **number of steps engaged with faulty probe.** (0÷6).
- PoPr** **Capacity engaged with faulty probe:** (0÷100%) it's used only if CtyP=dPo.

## 17.9 Alarms – fans section

- LAF:** **Low pressure alarm – fans section:** The measurement unit depends on the dEU parameter: (FA04 ÷ HAF bar; -50.0÷HAF °C; FA04÷HAF PSI; -58÷HAF °F) It's independent from the set point. When the value LAF is reached the LA2 alarm is enabled, (possibly after the **AFd** delay time).
- HAF:** **High pressure alarm – fans section:** The measurement unit depends on the dEU parameter: (LAF÷FA20 bar; LAF÷150.0 °C; LAF÷FA20 PSI; LAF÷302 °F). It's independent from the set point. When the value HAF is reached the HA2 alarm is enabled, (possibly after the **AFd** delay time).
- AFd:** **Low and High pressure alarms delay – fans section:** (0÷255 min) time interval between the detection of a pressure alarm condition in the fans section and alarm signaling.
- HFC** **Compressors off with high pressure (temperature) alarm for fans**  
**no** = compressors are not influenced by this alarm  
**yES** = compressors are turned off in case of high pressure (temperature) alarm of fans
- dHF** **Interval between 2 compressors turning off in case of high pressure (temperature) alarm for fans** (0 ÷ 255 sec)
- PnF:** **High pressure-switch intervention numbers – fans section:** (0÷15 with 0 the manually unlocking is disabled) if the high pressure-switch is enabled PnF times in the PiF interval, the controller is locked. **It can be unlocked only manually.** See paragraph 22. Every time the pressure-switch is enabled all the compressors are turned off and all the fans are turned on.
- PiF:** **Pressure-switch interventions time – fans section** (0÷255 min) Interval, linked to the PEn parameter, for counting interventions of the high pressure-switch..
- FPr** **Number of fans engaged with faulty probe.** (0÷#fans).

## 17.10 Dynamic set point for fan

- dSEP** **Dynamic set point reference probe**  
**nP:** no probe; function disabled  
**P3:** probe P3 (term. 38-42)  
**P4:** probe P4 (term. 22-23)
- dSES** **External temperature value to start dynamic regulation** (-50÷150°C; -58÷302 °F)
- dSEb** **External band width for dynamic set point** (-50.0 ÷ 50.0°C; -90 ÷ 90°F)
- dSEd** **Set point differential for dynamic set point:** (-20.0÷20.0°C; -50.0÷50.0PSI; -300÷300°F)

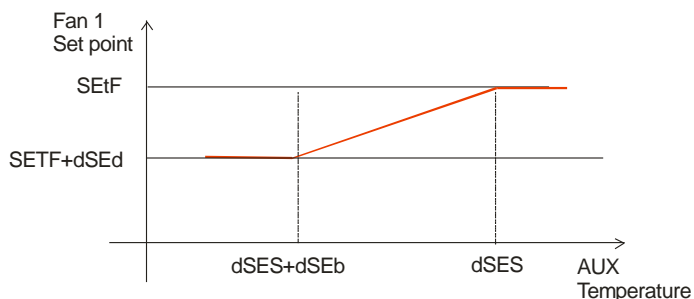

## 17.11 Analog output 1 (optional) – Terminals 25-26

### AoC Analog output 1 setting

tEn = 0÷10V output

cUr = 4-20mA output

### AOF Analog output 1 function

nu = analog output disabled;

Inc1= To drive inverter for suction frequency compressor, suction of circuit 1;

Inc2 = To drive inverter for suction frequency compressor, suction of circuit 2

inF= to drive ECI fan or inverter for fan

### InCP Inverter compressor always activated at first:

no: other compressors if available are allowed to start when the inverter compressor is locked by safety timers. This allows the system to satisfy the cooling demand when the inverter compressor is unavailable.

yES: the inverter compressor is always started as first. If unavailable due to safety timers the regulation will be locked till timers will be over.

### AOM Minimum value for analog output 1 (4 ÷ 20mA or 0÷10V)

### AOt Time of analog output 1 at max after the start (0÷15s)

### MPM Maximum % variation per minute of analog output 1: (nu; 1÷100)

nu = not used: function disabled

1÷100 = it sets the maximum percentage variation per minute of the analog output.

### SAO Percentage of analog output 1 in case of probe failure: (0 ÷ 100%)

### AOH Maximum analog output 1 percentage when silence mode function is enabled (0÷100)

## 17.12 Analog output 2 (optional) – Terminals 27-28

### 2AoC Analog output 2 setting

tEn = 0÷10V output

cUr = 4-20mA output

### 2AOF Analog output 2 function

nu = analog output disabled;

Inc1= To drive inverter for suction frequency compressor, suction of circuit 1;

Inc2 = To drive inverter for suction frequency compressor, suction of circuit 2

inF= to drive ECI fan or inverter for fan

### 2AOM Minimum value for analog output 2 (4 ÷ 20mA or 0÷10V)

### 2AOt Time of analog output 2 at max after the start (0÷15s)

### 2MPM Maximum % variation per minute for analog output 2: (nu; 1÷100)

nu = not used: function disabled

1÷100 = it sets the maximum percentage variation per minute of the analog output.

### 2SAO Percentage of analog output 2 in case of probe failure: (0 ÷ 100%)

**2AOH Maximum analog output 2 percentage when silence mode function is enabled  
(0÷100)**

**17.13 Other**

- tbA Alarm relay silencing:** by pushing one of the keypad buttons. **no**= alarm relay stays on; **yES**= alarm relay is switched off by pushing any keys.
- OAP Alarm relay output polarity:** **cL**=closed when activated; **oP**= opened when activated
- oFF Switching ON/OFF enabling from keyboard:** (**no** = disabled; **yES**= enabled) It permits the switching ON/OFF of the instrument by pressing the SET key for more than 4s.
- bUr Buzzer enabling**  
**no** = the buzzer is not used in case of alarm  
**yES** = buzzer is used in case of alarm
- Adr: Serial address** (1 –247) It is used in monitoring system.
- rEL Software release** for internal use.
- Ptb Parameter table code:** readable only.
- Pr2 Access to Pr2 parameter level**



# 18. Even Capacity Compressors (CtyP = Spo)

## 18.1 Compressors With Same Capacity – Dead band control

This regulation is applied both to the circuit 1 and the circuit 2.

The neutral zone (Pbd) is symmetrical compared to the target set point, with extremes: set+Pbd/2 ... set-Pbd/2. If the pressure (temperature) is inside this zone the controller maintains the same number of loads switched on and off, without changing anything.

When the pressure (temperature) go out from the zone, regulation starts. If the pressure is greater than SET+Pbd/2, the loads are switching on with timing given by parameters: don and doF.

A load is turned on only if his safety times **onon**, **oFon**, **donF** are over.

Regulation stops when the pressure (temperature) comes back into the neutral zone.

In the following a simplify example that explains the regulation in neutral zone for compressor homogeneous with 1 step for each compressors. The safety times onon, oFon and donF are not considered. In the real regulation any load is entered or turned off only if these times are over.

### Ex. Dead band control, compressors with same capacities, 1 step for each compressor.

In this example:

**oA1 = cPr1; oA2 = cPr1; oA3 = cPr1; oA4 = nu;** number of compressors

**CtyP = SPO** homogeneous compressors;

**Sty = yES** rotation

**FdLy = no** "don" delay not enabled at first calling after an equilibrium condition.

**dLF = no** "doF" delay not enabled at first calling after an equilibrium condition.

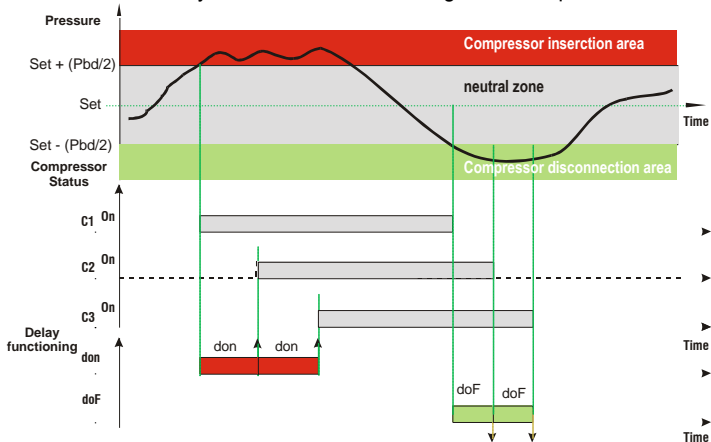

## 19. UNEVEN CAPACITY COMPRESSORS (CtyP = dPO)

With **CtyP = dPO** the regulation is performed for uneven capacity compressors. In this case the capacity supplied by the system is a combination of the capacity of different compressors.

The capacity of each compressor has to be set in the parameters PC1...PC4.

The regulation algorithm supply a combination of the available capacities, starting from the lower ones and increasing step by step according to the requests coming from the system.

With uneven capacity compressors, the algorithm doesn't distribute the working time between the various compressors to ensure even run times.

### 19.1.1 Regulation example

oA1 = CPR1, oA2 = CPR1, oA3 = CPR1, OA4 = CPR1,.

CtyP = dPo

Pc1 = 10; Pc2 = 15 Pc3 = 30; Pc4 = 40

STEP	Pc1 = 10;	Pc2 = 15	Pc3 = 30;	Pc4 = 40	SYSTEM CAPACITY
1	ON	-	-	-	10
2	-	ON	-	-	15
3	ON	ON	-	-	25
4	-	-	ON	-	30
5	-	-	-	ON	40
6	-	ON	ON	-	45
7	ON	-	-	ON	50
8	-	ON	-	ON	55
9	ON	ON	-	ON	65
10	-	-	ON	ON	70
11	ON	-	ON	ON	80
12	-	ON	ON	ON	85
13	ON	ON	ON	ON	95

The transition between the various steps can be carried out only if the safety timers (onon, oFon, donF) have been expired, otherwise the first available step is used.

## 20. SCREW COMPRESSORS (CtyP = Scr)

\*\*\*\*\*READ CAREFULLY BEFORE PROCEEDING\*\*\*\*\*

The controller doesn't manage any time limitation on the activation of the 25% capacity valve.

If the compressor is not design for a long activation of the 25% capacity valve, an external device able to exclude this situation MUST be used. !!!!!

Dixell can't be considered responsible for possible damages caused from this situation

The controller is able to manage only 1 screw compressor, operating on circuit 1.

Loads activation is managed by the neutral zone.

To set it:

**CtyP = Scr:** in this way the compressor is managed as screw compressor, and the relays set as steps, will follow special activation rules, as explained in the following chapters.

The activation of the valve is designed according to the Bitzer, Hanbell compressors.  
 Set the relay oA1 = CPr1, it will manage the compressor.  
 Set the oA2, oA3 and oA4 as "StP".

## 20.1 Regulation with screw compressors like Bitzer/ Hanbell/ Refcomp etc

Screw compressors like Bitzer use up to 3 valves for the power regulation.

### 20.1.1 Relay activation

ES. Compressor with 4 steps:

**oA1** = CPr1; **oA2** = StP; **oA3** = StP; **oA4** = StP; **CtyP** = Scr

a. Activation with valves ON due to voltage presence (StP=cL).

	<b>oA1 = Screw1</b>	<b>oA2 = StP</b>	<b>oA3 = StP</b>	<b>oA4 = StP</b>
<b>Step 1 (25%)</b>	ON	ON	OFF	OFF
<b>Step 2 (50%)</b>	ON	OFF	ON	OFF
<b>Step 3 (75%)</b>	ON	OFF	OFF	ON
<b>Step 4 (100%)</b>	ON	OFF	OFF	OFF

b. Activation with valves ON due to voltage absence (StP=oP).

	<b>C1 = Screw1</b>	<b>C2 = stp</b>	<b>C3 = stp</b>	<b>C4 = stp</b>
<b>Step 1 (25%)</b>	ON	OFF	ON	ON
<b>Step 2 (50%)</b>	ON	ON	OFF	ON
<b>Step 3 (75%)</b>	ON	ON	ON	OFF
<b>Step 4 (100%)</b>	ON	ON	ON	ON

## 21. Fan regulation

The fan regulation band **Pb** is divided by the number of fans:

The numbers of fans switched ON is proportional to the value of the input signal: when this distance itself from the target set point and enters the various bands, the fans are switched ON, to be then turned OFF when the signal brings near the set point.

In this way if the pressure is greater than regulation band, all the fans are on, if the pressure (temperature) is lower than the regulation band all the fans are off. Naturally also for this regulations all the delays (Fon and FoF) are valid.

### Regulation according to the running hours

The algorithm switches on and off the loads according to the running hours of each load. In this way the running hours are balanced.

#### Example

4 Fans: **oA1 = FAn; oA2 = FAn; oA3 = FAn; oA4 = FAn;**  
**rot = yES** rotation enabled

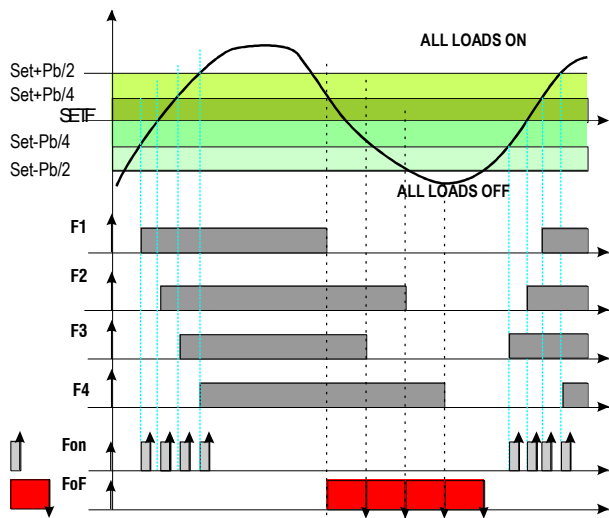

## 21.1 Condenser with Inverter or Eci Fans–Analog Output Setting

This configuration is used when all fans of the condensing group are ECI fans or driven by one inverter or a chopped phase driver.

The capacity used by the inverter is proportional to the delivery pressure value inside the regulation band ( $\text{SETF} - \text{Pb}/2 \div \text{SETF} + \text{Pb}/2$ ).

### 21.1.1 Condenser fan configurations and Parameters

Parameter	Description	Action
<b>oA(i) = inF</b>	Set 1 relay for inverter	One relay is used to enable the action of the inverter.
<b>AoC = tEn</b>	Analog output setting	Set the output as 0-10V
<b>AoF = InF</b>	Analog output function	Set the output to drive ECI or inverter fan
<b>AOM = 0</b>	Minimum value for analog output	The minimum voltage is 0V. <b>NOTE:</b> verify on the inverter of ECI fan of chopped phase driver that with this input a proper output is supplied to the fan.
<b>AOt = 5</b>	Time of analog output at max after the start	To start the fan the controller supplies 10V output for 5s, then starts standard regulation
<b>MPM = 100</b>	Maximum % variation per minute	The analog output takes 1 min to move from the min to the maximum

### 21.1.2 How to set it

Parameters involved: **oA(i) = inF; AoC = tEn, AoF = InF, Aot = 0, AOM = 30, MPM = 100**

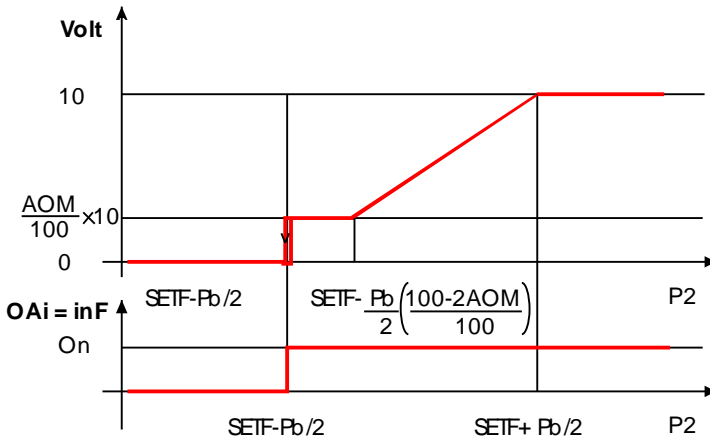

- If required, set a relay to drive the invert (is used to signal to the inverter to start and stop the regulation), by setting: **oA(i) = inF** inverter for fans
- Set the kind of signal of the analog output current (4-20ma) or voltage (0-10V) by the **Analog output setting** parameter "**AoC**": **tEn** = 0÷10V output; **cUr** = 4-20mA output
- Set the function of the analog output: **AoF = InF**
- Set the time of the analog output at max after start up EI: Aot = 3s**
- Set the max % variation per min (MP)**
- At last set also the percentage of analog output in case of probe failure: (0 ÷ 100%)**SAO**

## 22. Alarm list

Usually alarm conditions are signaled by means of:

1. Activation of alarm output
2. Buzzer activation
3. Message on proper display
4. Log of alarm: code and duration.

The table at paragraph 22.3

### 22.1 Types of alarms and signaling managed

#### 22.1.1 A12: Configuration alarm

The following configuration parameters are checked after each modification.:

- OA1+ OA4** Outputs 2- 4 configuration
- P2C** Second probe configuration.

When these parameters are set in wrong way an alarm message is generated: the label **A12** is shown on the upper display, while the lower display the following messages are shown:

Mess.	Errata	Corrige
<b>Too Many dGS output</b>	More than one oAi has been set as dGs (digital scroll)	<ul style="list-style-type: none"> <li>• Check the oAi parameters and set them different from dGS.</li> </ul>
<b>Too Many dGSSt output</b>	One oAi has been set as dGSSt (triac for digital scroll)	<ul style="list-style-type: none"> <li>• Check the oAi parameters and set them different from dGSSt.</li> </ul>
<b>Too Many 6dG output</b>	More than one oAi has been set as 6dG (triac for digital scroll)	<ul style="list-style-type: none"> <li>• Check the oAi parameters and set them different from 6dG.</li> </ul>
<b>6dG bEForE dGS ConFig Error</b>	oAi configured as 6dG before the dGS	<ul style="list-style-type: none"> <li>• Check the oAi parameters and set 6dG after dGS.</li> </ul>
<b>dGSSt OutPut Error</b>	One oAi has been set as dGSSt (triac for digital scroll)	<ul style="list-style-type: none"> <li>• Check the oAi parameters and set them different from dGSSt.</li> </ul>
<b>dGS not PrESent</b>	One oAi has been set as dGs (digital scroll)	<ul style="list-style-type: none"> <li>• Check the oAi parameters and set them different from dGS.</li> </ul>
<b>dGSSt not PrESent</b>	The digital output for digital compressor has not been set	<ul style="list-style-type: none"> <li>• Check the oAi parameters and set them different from dGS or 6dG.</li> </ul>
<b>StEP ConFiG Error</b>	Load (step) configuration error	<ul style="list-style-type: none"> <li>• A relay oA(i) has been set as compressor without a previous relay oA(i-1) has been set as compressor. EI oA1 = StP</li> </ul>
<b>Fan ProbE not PrESent</b>	None probe has been set for to manage the fan	Check parameters <b>FPb , P1C , P2C , P3C</b> , and then set a probe for this function
<b>No P3 ProbE For</b>	None probe has been set	Check parameters <b>LiPr , P3C , P4C</b> , and

Mess.	Errata	Corrige
Lin out	for the Liquid Injection function	then set a probe for this function.
no LoAdS For rEGuLAtion	None oA(i) is set as compressors or fans	<ul style="list-style-type: none"> <li>Check the setting of oA1, oA2, oA3, oA4, oA5, oA6 parameters</li> </ul>
ProbE tyPE For dynAMic Set	A current of voltage transducer has been set for the "Dynamic set point for fan" function	<ul style="list-style-type: none"> <li>Set a temperature probe for the "Dynamic set point for fan" function, par. "dSEP"</li> </ul>
No ProbE For dynAMic Set	None probe has been set for the "Dynamic set point for fan" function	<ul style="list-style-type: none"> <li>Set a temperature probe for the "Dynamic set point for fan" function, par. "dSEP".</li> </ul>
too MANy InC1	More than one oAi has been set as inC1 (inverter for suction 1)	<ul style="list-style-type: none"> <li>Check the oAi parameters and set only 1 as "inC1".</li> </ul>
No AnALoGuE out For InC1	None analogue output has been set as "inC1"	<ul style="list-style-type: none"> <li>Check AoF and 2AoF and set one of them as "inC1"</li> </ul>
too MANy InC2	More than one oAi has been set as inC2 (inverter for suction 2)	<ul style="list-style-type: none"> <li>Check the oAi parameters and set only 1 as "inC2".</li> </ul>
No AnALoGuE out For InC2	None analogue output has been set as "inC2"	<ul style="list-style-type: none"> <li>Check AoF and 2AoF and set one of them as "inC2"</li> </ul>
too MANy InF	More than one oAi has been set as inF (inverter for fan)	<ul style="list-style-type: none"> <li>Check the oAi parameters and set only 1 as "inF".</li> </ul>
No AnALoGuE out For InF	None analogue output has been set as "inF"	<ul style="list-style-type: none"> <li>Check AoF and 2AoF and set one of them as "inF"</li> </ul>
CPr Circuit conFIG Error	The kind of outputs are not compatible with the 2 suction circuits	<ul style="list-style-type: none"> <li>Check parameters oA(i) , CtyP and set CtyP different from Scr.</li> </ul>
AO1 And AO2 SAME Function	AoF and 2AoF have the same setting	<ul style="list-style-type: none"> <li>Set AoF and 2AoF properly.</li> </ul>

### **22.1.2 E01L, Electronic Pressure switch alarm, suction 1 section**

#### **Parameters**

**ELP: Electronic pressure switch threshold, section 1:** (-50°C÷SETC; -58°F÷SETC; PA04÷SETC); Pressure / Temperature value at which all the compressors are switched off. It has to be set some degrees above the mechanical low pressure switch value, in order to prevent mechanical low pressure activation.

#### **Actions**

**Electronic low pressure:** every time the suction temperature/pressure is less than ELP value all the compressors are switched off. The instrument restarts the standard operating mode when pressure/ temperature increases.

### **22.1.3 E0H1, E0L1, Pressure switch alarm, suction 1, and condensing sections**

#### **Terminals**

**WARNING: THESE TERMINALS REQUIRE MAIN VOLTAGE CONNECTION**

Low pressure switch 1 input: 44-45, high pressure switch input: [45-46].

## Parameters

**iP10: Low pressure switch polarity:** It establishes if the input is activated by giving (iP10=cL) or by removing (iP10=oP) main voltage to the terminals.

**iP09: High pressure switch polarity:** It establishes if the input is by giving (iP09=cL) or by removing (iP09=oP) main voltage to the terminals.

## Actions

**Low pressure:** every time the inputs are activated all the compressors are switched off. The instrument restart the standard operating mode when the input is disabled. If there are PEn activation in the PEi time, only manual resetting is allowed, by pressing the **DOWN** key for 3s or by turning off and on the instrument.

**High pressure:** every time the inputs are activated all the compressors are switched off and fans are switched on. The instrument restart the standard operating mode when the input is disabled. If there are PnF activation in the PiF time, only manual resetting is allowed, by pressing the **DOWN** key for 3s or by turning off and on the instrument.

### 22.1.4 EAI÷EA4: Compressors and fans safeties alarm.

#### Terminals

**WARNING: THESE TERMINALS REQUIRE A FREE OF VOLTAGE CONNECTION.**

The terminals (from 13 TO 18) really used depends on the number of loads. The protections regarding the compressors and fans are connected to these inputs. If one of these protections is enabling (E.I. for lack of oil or overheating, etc,) the corresponding load is turn off.

#### Parameters

**iP01, iP02, iP03, iP04:** establish if the input is activated by closing (cL) or by opening (=oP) the terminals.

#### Actions

Every time one input is activated the corresponding output is turned off.

#### Recovery

Recovery depends on **ALMr** parameter:

With **ALMr = no** The instrument restart the standard operating mode when the input is disabled.

With **ALMr = yES** manual recover for the alarms of compressors and fans. Push the **DOWN** key for 3s.

### 22.1.5 P1, P2; P3,P4: probe failure alarm

It is generated by failure in the probe P1, P2 , P3 or P4.

In case of **P1** fault, number of steps engaged depends on the **SPr** parameter

In case of **P2** fault, number of fans engaged depends on the **FPr** parameter

#### If the P3 or P4 probes are used for dynamic set point

The function is disabled and only the standard set point is used.

#### Recovery

Automatic as soon as probe restarts working.



### 22.1.6 CIHA, CILA, F-HA, F-LA High and low pressure (temperature) alarms for compressors or fans

This alarm signals that the pressure (temperature) is out of limits established by parameters LAL and HAL for compressors and LAF –HAF for fans.

The **tAo** and **AFd** parameters set the delay between alarm condition and alarm signaling.

#### **Action**

The alarm is signaled with standard action. The outputs are unchanged.

## **22.2 Buzzer muting**

Press any buttons to silence the buzzer during an alarm condition.

Hold pressed for more than 3 seconds switch off the alarm relay during an alarm condition

## **22.3 Alarm conditions – summary table**

Code	Description	Cause	Action	Reset
E01L	Low electronic pressure-switch alarm, suction 1	Pressure/temperature less than ELP value	All compressors of the circuit 1 are turned off. Fans unchanged.	<b>Automatically</b> when the pressure/temperature increases more than ELP value
E01	Low pressure-switch alarm, suction 1	Low pressure switch input of circuit 1 enabled	All compressors of the circuit 1 (2) are turned off. Fans unchanged.	<p><b>Automatically</b> (if the number of activation are less than PEN in the PEi time) when the input is disable.</p> <ul style="list-style-type: none"> <li>- The compressors restarts working according to the working algorithm.</li> </ul> <p><b>Manually</b> (if PEN activation happened in the PEi time) When the input is disable:</p> <ol style="list-style-type: none"> <li>a. hold pressed the <b>Restart(DOWN)</b>key for 3s or</li> <li>b. turn off and on the instrument..</li> </ol> <ul style="list-style-type: none"> <li>- The compressors restarts working according to the working algorithm.</li> </ul>
E0H	High pressure switch alarm	High pressure switch input enabled	<ul style="list-style-type: none"> <li>- All compressors are turned off.</li> <li>- All fans are turned on.</li> </ul>	<p><b>Automatically</b> (if the number of activation are less than PEN in the PEi time) when the input is disable.</p> <ul style="list-style-type: none"> <li>- Compressors and fans restart working according to the working algorithm.</li> </ul> <p><b>Manually</b> (if PEN activation happened in the PEi time) When the input is disable:</p> <ul style="list-style-type: none"> <li>- hold pressed the <b>Restart(DOWN)</b> key for 3s or</li> <li>- turn off and on the instrument.</li> </ul> <p>Compressors and fans restarts working according to the working algorithm.</p>

Code	Description	Cause	Action	Reset
P1	P1 probe failure alarm	Probe failure or out of range	– The compressors are activated according to the SP <sub>r</sub> or PoPr parameters.	<b>Automatically</b> as soon as the probe restarts working.
P2	P2 probe failure alarm	Probe failure or out of range	– The fans are activated according to the FPr parameters.	<b>Automatically</b> as soon as the probe restarts working.
P3	P3 probe failure alarm	Probe 3 failure or out of range	– The functions related to the third probe are disabled.	<b>Automatically</b> as soon as the probe restarts working.
P4	P4 probe failure alarm	Probe 4 failure or out of range	– The functions related to the fourth probe are disabled.	<b>Automatically</b> as soon as the probe restarts working.
EA1 EA2 EA3 EA4	Load safeties alarm	Safeties compressor/fan input activation. NOTE: with step compressors 1 input for each compressor has to be used.	– the corresponding load is turned off. (with step compressors all relays referred to the input are disabled).	Recovery depends on <b>ALMr</b> parameter: With <b>ALMr = no</b> The instrument restart the standard operating mode when the input is disabled. With <b>ALMr = yES</b> manual recover for the alarms of compressors and fans. Push the <b>DOWN</b> key for 3s.
C1-LA	Minimum pressure (temperature) alarm compressors section	Suction pressure or temperature lower than LAL value	signaling only	<b>Automatically:</b> as soon as the pressure or temperature reaches the (LAL+ differential) value. (differential = 0.3bar or 1°C)
F-LA	Minimum pressure (temperature) alarm fans section	Condensing pressure or temperature lower than LAF value	signaling only	<b>Automatically:</b> as soon as the pressure or temperature reaches the (LAF+ differential) value. (differential = 0.3bar or 1°C)
C1-HA	Maximum pressure (temperature) alarm compressors section	Suction pressure or temperature higher than HAL value	signaling only	<b>Automatically:</b> as soon as the pressure or temperature reaches the (HAL - differential) value. (differential = 0.3bar or 1°C)
F-HA	Maximum pressure (temperature) alarm fans section	Condensing pressure or temperature higher than HAF value	Depends on the parameter HFC	<b>Automatically:</b> as soon as the pressure or temperature reaches the (HAF - differential) value. (differential = 0.3bar or 1°C)
A5	Liquid level alarm	Input enabled	signaling only	<b>Automatically</b> as soon as the input is disabled

Code	Description	Cause	Action	Reset
A12	Configuration alarms	See par. 18.1	–	
A14	Load maintenance alarm	A load has worked for the hour set in the SEr parameter	- signaling only	<b>Manually:</b> reset the running hour of the compressor (see par.13 Running hours of loads)
EA	External alarm	The configurable dig. Input set as EA is activated	signaling only	<b>Automatically</b> as soon as the input is disabled
InF	Inverter fan alarm	The configurable dig. Input set as inF is activated	The analog out set as INF is switched off	<b>Automatically</b> as soon as the input is disabled

## 23. Technical features

**Housing:** Self extinguishing ABS.

**Case:** 4 DIN modules 70x135mm with male and female connectors; depth 60mm.

**Mounting:** DIN RAIL mounted in an omega (3) din rail.

**Protection:** IP20.

**Connections:** pluggable screw terminal block  $\leq 2.5 \text{ mm}^2$  wiring.

**Power supply:** 230Vac  $\pm 10\%$ . 50-60Hz, or 115Vac  $\pm 10\%$ . 50-60Hz or 24Vac  $\pm 10\%$ . 50-60Hz

**Power absorption:** 6VA max.

**Display:** 4 digits red led and 4 digit orange led.

**Inputs:** up to 4 NTC probes, or up to 3 4 $\div$ 20mA or up to 0.5 $\div$ 4.5Vdc transducer.

**Digital inputs:** up to 8 free voltage, 2 inputs main voltage

**Relay outputs:** 4 relay SPST 5(3)A, 250Vac

**Analogue output:** 2 x 4 $\div$ 20mA or 0 $\div$ 10V,

**Serial output :** RS485 standard **Communication protocol:** ModBus – RTU

**Data storing:** on the non-volatile memory (EEPROM).

**Kind of action:** 1B; **Pollution grade:** normal; **Software class:** A.

**Operating temperature:** -10 $\div$ 60 °C.; **Storage temperature:** -25 $\div$ 80 °C.

**Relative humidity:** 20 $\div$ 85% (no condensing)

**Measuring range: NTC probe:** -40 $\div$ 110°C.

**Resolution:** 0,1 °C; 1°F; 0.1bar; 1 PSI;

**Accuracy (ambient temp. 25°C):**  $\pm 0,7 \text{ °C} \pm 1 \text{ digit}$

## 24. Parameters – Default values

Label	Valori	Menù	Descrizione Parametri	Limiti
<b>StC1</b>	-10.0	Pr1	Set point for compressors	LSE+HSE
<b>SEtF</b>	35.0	Pr1	Set point for fans	LSF+HSF
<b>OA1</b>	CPr	Pr2	Load 1 configuration	nu - CP1 - CP2 - StP - dGS - 6dG - dGSt - lnC1 - lnC2 - FAn - lnF - Ln - ALr
<b>OA2</b>	CPr	Pr2	Load 2 configuration	nu - CP1 - CP2 - StP - dGS - 6dG - dGSt - lnC1 - lnC2 - FAn - lnF - Ln - ALr
<b>OA3</b>	CPr	Pr2	Load 3 configuration	nu - CP1 - CP2 - StP - dGS - 6dG - dGSt - lnC1 - lnC2 - FAn - lnF - Ln - ALr
<b>OA4</b>	FAn	Pr2	Load 4 configuration	nu - CP1 - CP2 - StP - dGS - 6dG - dGSt - lnC1 - lnC2 - FAn - lnF - Ln - ALr
<b>CtyP</b>	SPo	Pr2	Compressor type	SPo, dPo, Scr
<b>StP</b>	oP	Pr2	Valve output polarity	OP - CL
<b>PC1</b>	20	Pr2	Capacity of compressor 1	0÷100
<b>PC2</b>	20	Pr2	Capacity of compressor 2	0÷100
<b>PC3</b>	20	Pr2	Capacity of compressor 3	0÷100
<b>PC4</b>	20	Pr2	Capacity of compressor 4	0÷100
<b>FtyP</b>	404	Pr2	Refrigerant gas type	r22 - 404 - 407A - 407C - 407F - 410 - 507 - 134 - CO2
<b>Sty</b>	yES	Pr2	Compressor Sequence type	no - yES
<b>Rot</b>	yES	Pr2	Fan Sequence type	no - yES
<b>P1C</b>	Cur	Pr2	P1 probe setting (4/20mA, 0-5V, ntc)	nP - Cur - tEn - ntc
<b>PA04</b>	-0.5	Pr2	4mA or 0.5V readout for P1 probe	(-1.0 ÷ PA20)BAR; (-15 ÷ PA20)PSI; (-100 ÷ PA20)KPA
<b>PA20</b>	11.0	Pr2	20mA or 4.5V readout for P1 probe	(PA04 ÷ 51.0)BAR; (PA04 ÷ 750)PSI; (PA04 ÷ 5100)KPA
<b>CAL</b>	0.0	Pr2	P1 probe offset	-12.0÷12.0(°C); -20÷20 (°F); 12.0÷12.0 (bar); -200÷200 (PSI) -999÷999 (kPA)
<b>P2C</b>	Cur	Pr2	P2 probe setting (4/20mA, 0-5V, ntc)	nP - Cur - tEn - ntc
<b>FA04</b>	0.0	Pr2	4mA or 0.5V readout for P2 probe	(-1.0 ÷ FA20)BAR; (-15 ÷ FA20)PSI; (-100 ÷ FA20)KPA
<b>FA20</b>	30.0	Pr2	20mA or 4.5V readout for P2 probe	(FA04 ÷ 51.0)BAR; (FA04 ÷ 750)PSI; (FA04 ÷ 5100)KPA
<b>FCAL</b>	0.0	Pr2	P2 probe offset	-12.0÷12.0(°C); -20÷20 (°F); 12.0÷12.0 (bar); -200÷200 (PSI) -999÷999 (kPA)
<b>P3C</b>	nP	Pr2	P3 probe setting (4/20mA, 0-5V, ntc)	nP - Cur - tEn - nt10 - nt86
<b>3P04</b>	-0.5	Pr2	4mA or 0.5V readout for P3 probe	(-1.0 ÷ FA20)BAR; (-15 ÷ FA20)PSI; (-100 ÷ FA20)KPA
<b>3P20</b>	11.0	Pr2	20mA or 4.5V readout for P3 probe	(FA04 ÷ 51.0)BAR; (FA04 ÷ 750)PSI; (FA04 ÷ 5100)KPA
<b>O3</b>	0.0	Pr2	P3 probe offset	-12.0÷12.0(°C); -20÷20 (°F); 12.0÷12.0 (bar); -200÷200 (PSI); -999÷999 (kPA)
<b>P4C</b>	nP	Pr2	P4 probe setting (NTC 10K, NTC 86K)	nP - nt10 - nt86
<b>O4</b>	0.0	Pr2	P4 probe offset	-12.0÷12.0(°C); -20÷20 (°F)
<b>FPb</b>	P2	Pr2	Probe setting for fan	nP - P1 - P2 - P3
<b>iF07</b>	ES	Pr2	Configurable digital input i1F function (terminals 22-23)	nu - OA1- OA2 - OA3 - OA4 - OA5 - OA6 - lnF - LP1 - LP2 - HP - ES - OFF - LL - SIL - EAL
<b>iF08</b>	LL	Pr2	Configurable digital input i2F function (terminals 22-24):	nu - OA1- OA2 - OA3 - OA4 - OA5 - OA6 - lnF - LP1 - LP2 - HP - ES - OFF - LL - SIL - EAL
<b>iP01</b>	cL	Pr2	Safety input for Load 1 polarity (13-14):	OP - CL
<b>iP02</b>	cL	Pr2	Safety input for Load 2 polarity (13-15):	OP - CL
<b>iP03</b>	cL	Pr2	Safety input for Load 3 polarity (16-17):	OP - CL

Label	Valori	Menù	Descrizione Parametri	Limiti
<b>iP04</b>	cL	Pr2	Safety input for Load 4 polarity (16-18):	OP - CL
<b>iP07</b>	cL	Pr2	Configurable digital input i1F polarity (22-23):	OP - CL
<b>iP08</b>	cL	Pr2	Configurable digital input i2F polarity (22-24)	OP - CL
<b>iP09</b>	cL	Pr2	Polarity of High pressure-switch alarm (terminals 45-46)	OP - CL
<b>iP10</b>	cL	Pr2	Polarity of Low pressure-switch alarm (terminals 44-45)	OP - CL
<b>did</b>	20	Pr2	Liquid level alarm, signaling delay	0 ÷ 255 (min.)
<b>didA</b>	20	Pr2	External alarm, signaling delay:	0 ÷ 255 (min.)
<b>ALMr</b>	no	Pr2	Manual reset for compressor/fan alarms	no - yES
<b>dEU</b>	tPr	Pr2	Displaying measurement unit: pressure or temperature	tMP - PrS
<b>CF</b>	°C	Pr2	Measurement unit for temperature	°C - °F
<b>PMU</b>	Bar	Pr2	Measurement unit for pressure	BAr - PSI - PA
<b>rES</b>	dE	Pr2	Resolution for display and parameters	in - dE
<b>dEU1</b>	tPr	Pr2	Upper display: pressure or temperature selection	tMP - PrS
<b>dSP2</b>	P2	Pr2	Lower display default visualization	nu - P1 - P2 - P3 - P4 - StC1 - StC2 - SEtF
<b>dEU2</b>	tPr	Pr2	Lower display: pressure or temperature selection	tMP - PrS
<b>Pbd</b>	5.0	Pr2	Proportional band for compressors regulation, suction 1	0.1÷30.0(°C); 1+50 (°F); 0.1÷10.0(BAR); 1÷150(Psi) 10÷1000(KPA)
<b>rS</b>	0.0	Pr2	Band offset, suction 1	-12.0÷12.0(°C) -20÷20(°F) -12.0÷12.0(BAR); -200÷ 200(Psi) -999÷999(KPA)
<b>inC</b>	500	Pr2	Integral time, suction 1	0 ÷ 999 sec
<b>ton</b>	60	Pr2	Time with Inverter at maximum capacity before starting a new load	0÷255s
<b>toF</b>	5	Pr2	Time with Inverter at minimum capacity before starting a new load	0÷255s
<b>ESC</b>	0.0	Pr1	Energy saving for compressors regulation	-50.0÷50.0(°C) -90÷90(°F) -20.0÷20.0(BAR) -300÷300(Psi) -2000÷2000(KPA)
<b>OnOn</b>	5	Pr2	Minimum delay between 2 switching on of the same compressor	0 ÷ 255 (min.)
<b>OFOn</b>	2	Pr2	Delay between the switching off and on of the same compressor	0 ÷ 255 (min.)
<b>don</b>	01:00	Pr2	Time delay between the insertion of two different loads	0 ÷ 99.5 (min.10sec)
<b>doF</b>	00:10	Pr2	Time delay between switching off of two different compressors	0 ÷ 99.5 (min.10sec)
<b>donF</b>	00:30	Pr2	Minimum time a stage stays ON	0 ÷ 99.5 (min.10sec)
<b>MAon</b>	0	Pr2	Maximum time a stage stays switched ON	0 ÷ 24 (hour)
<b>FdLy</b>	no	Pr2	'don' delay enabled also for the first request	no - yES
<b>FdLF</b>	no	Pr2	'doF' delay enabled also for the first switching off	no - yES
<b>odo</b>	20	Pr2	Regulation delay at power on	0 ÷ 255 (sec.)
<b>LSE</b>	-40.0	Pr2	Minimum set point (compressors)	-50.0÷HSE(°C) -58.0÷HSE(°F) PA04÷HSE(BAR,PSI,KPA)
<b>HSE</b>	10.0	Pr2	Maximum set point (compressors)	LSE÷150.0(°C) LSE÷302(°F) LSE÷PA20(BAR, PSI , KPA)
<b>Lit</b>	90.0	Pr2	Set point for liquid injection	0.0 ÷ 180.0(°C) 32 ÷ 356(°F)
<b>Lid</b>	10.0	Pr2	Differential for liquid injection	0.1 ÷ 25.5° (°C) 1 ÷ 50° (°F)
<b>LiPr</b>	nP	Pr2	Probe selection for liquid injection	nP - P3 - P4
<b>Pb</b>	5.0	Pr2	Proportional band for fan regulation	0.1÷30.0(°C) 1÷50 (°F) 0.1÷10.0(BAR) 1÷150(Psi) 10÷1000(KPA)

Label	Valori	Menù	Descrizione Parametri	Limiti
<b>ESF</b>	0.0	Pr2	Energy saving differential for fan regulation	-50.0÷50.0(°C) -90÷90(°F) -20.0÷20.0(BAR) -300÷300(PSI) -2000÷2000(KPA)
<b>PbES</b>	0.0	Pr2	Band offset for fan regulation in ES	-50.0÷50.0(°C) -90÷90(°F) -20.0÷20.0(BAR) -300÷300(PSI) -2000÷2000(KPA)
<b>Fon</b>	30	Pr2	Time delay between the insertion of two different fan	0 ÷ 255 (sec)
<b>FoF</b>	15	Pr2	Time delay between switching off of two different fan	0 ÷ 255 (sec)
<b>LSF</b>	10.0	Pr2	Minimum set point (fan)	-50.0÷HSF(°C) -58.0÷HSF(°F) FA04(FPb)+HSF(BAR , PSI , KPA)
<b>HSF</b>	50.0	Pr2	Maximum set point (fan)	LSF÷150.0(°C) LSF÷302(°F) LSF÷FA20 (BAR , PSI , KPA)
<b>PAO</b>	30	Pr2	Alarm probe delay at power on	0 ÷ 255 (min.)
<b>LAL</b>	-40.0	Pr1	Pressure alarm set low limit (compressors)	-50.0÷HAL(°C); -58÷HAL(°F); PA04÷HAL(BAR , PSI , KPA)
<b>HAL</b>	10.0	Pr1	Pressure alarm set high limit (compressors)	LAL÷150.0(°C); LAL÷302(°F); LAL÷PA20(BAR , PSI , KPA)
<b>tAo</b>	15	Pr1	Pressure/temperature alarm delay (compressors)	0 ÷ 255 (min.)
<b>ELP</b>	-45.0	Pr2	Electronic pressure switch threshold	-50.0÷STC1(°C) -58÷STC1(°F) PA04÷STC1(BAR , PSI , KPA)
<b>SEr</b>	999	Pr2	Working hour alarm set (tenth of ours)	1 ÷ 999 (0= disabled) (10 hour)
<b>PEn</b>	5	Pr2	Low Pressure switch maximum activations	0 ÷ 15
<b>PEI</b>	60	Pr2	Low Pressure switch activations time	0 ÷ 255 (min.)
<b>SPr</b>	1	Pr2	Number of compressors ON with faulty probe	0 ÷ 6
<b>PoPr</b>	50	Pr2	Capacity engaged with suction 1 probe failure	0÷100
<b>LAF</b>	0.0	Pr1	Low pressure alarm set (fan)	-50.0÷HAF(°C); -58÷HAF(°F); FA04÷HAF(BAR , PSI , KPA)
<b>HAF</b>	60.0	Pr1	High pressure alarm set (fan)	LAF÷150.0(°C) LAF÷302(°F) LAF÷FA20(BAR , PSI , KPA)
<b>AFd</b>	5	Pr2	Pressure alarm delay	0 ÷ 255 (min)
<b>HFc</b>	YES	Pr2	Compressor off with high pressure (temperature) alarm	no – YES
<b>dHF</b>	5	Pr2	Interval between 2 compressors turning off with high pressure (temperature) alarm	0 ÷ 255 (sec.)
<b>PnF</b>	5	Pr2	Fan pressure switch maximum activations	0 ÷ 15
<b>PiF</b>	60	Pr2	Fan pressure switch activations time	0 ÷ 255 (min)
<b>FPr</b>	1	Pr2	Fan ON with faulty probe	0 ÷ 6
<b>dSEP</b>	nP	Pr2	Dynamic Set point function enabled	nP – P3 - P4
<b>dSES</b>	35.0	Pr2	External temperature set for DYNAMIC SET POINT function	-50.0 ÷ 150.0 (°C) -58 ÷ 302 (°F)
<b>dSEb</b>	10.0	Pr2	Proportional band DYNAMIC SET POINT	-50.0 ÷ 50.0(°C) -90 ÷ 90 (°F)
<b>dSEd</b>	0.0	Pr2	Differential for DYNAMIC SET POINT	-50.0÷50.0(°C) -90÷90(°F) -20.0÷20.0(BAR) -300÷300(PSI) -2000÷2000(KPA)
<b>AOC</b>	Cur	Pr2	Analogue output 1 working mode	Cur – tEn
<b>AOF</b>	nu	Pr2	Analog output 1 function	nu – lnC1 – lnC2 – lnF
<b>InCP</b>	no	Pr2	Frequency compressor always starts at first	
<b>AOM</b>	0	Pr2	Minimum value of analogue output 1	0 ÷ 100 (%)
<b>AOt</b>	5	Pr2	Time with analog output 1 at max when after exceeding AOM	0÷15s
<b>MPM</b>	100	Pr2	Maximum % variation per minute, analog output 1	nu, 1 ÷ 100%
<b>SAO</b>	80	Pr2	Percentage of analog output 1 in case of	0 ÷ 100 (%)

Label	Valori	Menù	Descrizione Parametri	Limiti
			probe failure	
<b>AOH</b>	70	Pr2	Maximum analog output 1 percentage when silence mode function is enabled	0 ÷ 100 (%)
<b>2AOC</b>	Cur	Pr2	Analogue output 2 working mode	Cur – tEn
<b>2AOF</b>	nu	Pr2	Analog output 2 function	nu – lnC1 – lnC2 – lnF
<b>2AOM</b>	0	Pr2	Minimum value of analogue output 2	0 ÷ 100 (%)
<b>2AOt</b>	5	Pr2	Time with analog output 2 at max when after exceeding AOM	0÷15s
<b>2MPM</b>	100	Pr2	Maximum % variation per minute, analog output 2	nu, 1 ÷ 100%
<b>2SAO</b>	80	Pr2	Percentage of analog output 2 in case of probe failure	0 ÷ 100 (%)
<b>2AOH</b>	70	Pr2	Maximum analog output 2 percentage when silence mode function is enabled	0 ÷ 100 (%)
<b>tbA</b>	YES	Pr1	Alarm relay silencing	no - yES
<b>OAP</b>	cL	Pr2	Polarity alarm relay	OP - CL
<b>oFF</b>	no	Pr2	off function enabled	no - yES
<b>bUr</b>	YES	Pr2	Buzzer enabled	no - yES
<b>Adr</b>	1	Pr2	Serial address	1 ÷ 247
<b>rEL</b>	3.0	Pr2	Release firmware	Readable only
<b>Ptb</b>		Pr2	Parameter table code	Readable only
<b>Pr2</b>	-	Pr1	Pr2 access	Readable only

**Dixell**



**Dixell S.r.l.** - Z.I. Via dell'Industria, 27 - 32010 Pieve d'Alpago (BL) ITALY  
 Tel. +39.0437.9833 r.a. - Fax +39.0437.989313 - EmersonClimate.com/Dixell - dixell@emerson.com