







XWEB300D/500D/500 EVO (v.1.7)

INSTALLATION MANUAL

TABLE OF CONTENTS

1. PRODUCT DISPOSAL (WEEE)	4
2. THE RECIPIENTS OF THIS MANUAL	4
3. PACKAGE	5
4. XWEB INSTALLATION	6
5. CONTROLLER INSTALLATION PROCEDURE	10
5.1 CONTROLLER CONFIGURATION	11
5.1.1 CONFIGURATION FOR XC400/600/800/900 and XH200/300/400 SERIES.....	11
5.1.2 CONFIGURATION FOR XJA/XJP/XJM MODELS	11
5.1.3 ENERGY METERS AND THIRD PARTY INSTRUMENT CONFIGURATION	12
6. REMOTE CONNECTIVITY	15
6.1 DESKTOP.....	15
6.2 MOBILE.....	15
6.3 CONNECTIVITY WITH CROSS CABLE	16
6.4 MODEM CONNECTIVITY (“OR POINT-TO-POINT CONNECTION”).....	17
6.4.1 SETTING UP THE REMOTE ACCESS CONNECTION.....	17
6.4.2 MAKING THE REMOTE ACCESS CALL	18
6.5 INTRANET (“OR LAN CONNECTION”) AND VPN CONNECTIVITY	19
6.6 INTERNET CONNECTIVITY ON PUBLIC IP	20
7. OPERATION	23
8. SYSTEM DATA	23
9. TRADEMARKS	23
10. NOTES	24

CAUTION: TO PREVENT FLAMES FROM DEVELOPING OR ELECTRIC SHOCK, AVOID ANY CONTACT BETWEEN THIS DEVICE AND RAIN OR WATER

	<p>CAUTION RISK OF ELECTRIC SHOCK DO NOT OPEN</p>		<p>CAUTION: TO REDUCE THE RISK OF ELECTRIC SHOCK, DO NOT REMOVE THE COVER IT DOES NOT CONTAIN ANY PARTS THAT REQUIRE SERVICING BY THE USER ALWAYS HAVE QUALIFIED STAFF PERFORM THE PROCEDURES.</p>
			<p>THE SYMBOL OF THE LIGHTNING BOLT INSIDE AN EQUILATERAL TRIANGLE IS USED TO ALERT THE USER OF THE POTENTIALLY DANGEROUS NON-INSULATED ELECTRICAL VOLTAGES</p>
			<p>THE SYMBOL OF THE EXCLAMATION MARK INSIDE AN EQUILATERAL TRIANGLE IS USED TO WARN THE USER THAT HE/SHE MUST PAY CLOSE ATTENTION TO THE TOPIC COVERED IN THIS MANUAL</p>

CAUTION	<p>This device must be installed exclusively by service staff with suitable technical training and experience, who are aware of the dangers that they are exposed to. The operations described herein are set forth exclusively for the service staff. The user is not enabled to open the device.</p>
	

CAUTION	<p>Only use modems that are officially supported by this monitoring unit. Dixell srl cannot be held responsible for any damage caused by the use of non-supported modems.</p>
	

CAUTION	<p>Dixell srl reserves the right to amend this manual without prior notice. The latest available version can be downloaded from the internet site.</p>
	

CAUTION	<p>The instructions contained in this manual are common for models XWEB3000EVO/XWEB5000EVO. Any particular features are specified expressly.</p>
	

CAUTION	<p>This control and monitoring unit fulfils EN 12830 for use with probes to detect measurements referred to in 13485</p>
	

CAUTION	<p>This is a class A product. It can cause radio-interference in residential environments. Should this occur, the user should take suitable counter-measures</p>
	

CAUTION	<p>Dixell srl reserves the right to vary the composition of its products without prior notice to the customer, ensuring the identical and unchanged features of the same</p>
	

CAUTION 	<p>The customer shall bear full responsibility and risk for product configuration in order to achieve the results pertaining to installation and/or final equipment/system. Upon the customer's request and following a specific agreement, Dixell s.r.l. may be present during the start-up of the final machine/application, as a consultant, however, under no circumstances can the company be held responsible for the correct operation of the final equipment/system.</p>
---	--

CAUTION 	<p>Since Dixell products form part of a very high level of technology, a qualification/configuration/programming/commissioning stage is required to use them as best as possible. Otherwise, these products may malfunction and Dixell cannot be held responsible. The product must not be used in any way that differs from that stipulated in the documentation</p>
---	---

1. PRODUCT DISPOSAL (WEEE)

With reference to the DIRECTIVE 2012/19 / UE OF THE EUROPEAN PARLIAMENT AND OF THE COUNCIL of 4 July 2012 on Waste Electrical and Electronic Equipment (WEEE), and to the relevant national implementation regulations, we inform you that users of EEE in households:

- there is an obligation not to dispose of WEEE as mixed urban waste and to separate waste collection of WEEE;
- Public or private collection systems required by local laws must be used for disposal. It is also possible, at the end of its life, to return the equipment to the distributor in case of purchase of a new one.
- This equipment may contain hazardous substances; improper use or incorrect disposal could have negative effects on human health and the environment.
-  The symbol shown on the product or on the packaging indicates that the product must be treated with separate waste.
- In case of incorrect disposal, sanctions can be applied as established by the local laws on waste disposal.

2. THE RECIPIENTS OF THIS MANUAL

The contents of this manual are intended for professional users, such as XWEB installers. It may also be of use to the administrator of the network that it is connected to.

The mechanical product drawings required for any form of intervention and the possible network configurations are all an integral part of this manual.

3. PACKAGE

Before opening the package make sure that the packaging is intact and that there is no sign of impact or tampering. Before starting any operation, it is necessary to check that the XWEB-EVO box contains:

- 1 XWEB-EVO Unit
- 1 Power cord for electrical connection to European mains (version XWEB500 only)
- 1 Quick installation guide
- Removable female connectors
 - DIN
 - 2x2 ways
 - 1x3 ways
 - 1x6 ways
 - COOLMATE
 - 1x7 ways
- 1 two-way jumper
- Modem antenna (on request)
- RJ11-RJ11 telephone cable (on request)



If one of the following parts is damaged, promptly contact your dealer.











You can also receive a modem - which will not be included in the same package - as an option. When using a connection through the modem, always make sure that the type of modem you are about to install is a Dixell-approved model; accordingly, Dixell will not be held responsible for the poor operation of devices that are not expressly approved. The user manual, in the "manuals" section of the Dixell site, contains a list of supported models.

4. XWEB INSTALLATION

For installation, the XWEB-EVO system must not be opened in any way. If the box is opened, the warranty will lapse. XWEB-EVO can be installed in various ways based on the model and type of user interface access that you wish to provide for the final user. The particular features of these types of connectivity are described herein.

CAUTION: in order to protect yourself and the XWEB, turn on the unit only after connecting all the electrical devices. In order to avoid accidental operation, connect the power cord only after connecting all the other external units.

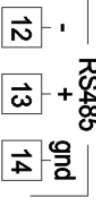
TERMINAL BLOCK (ONLY FOR DIN MODELS)

3		: Alarm relay 1 (**)	 : 1-2 XWEB Power supply	
4				
5		: Alarm relay 2 (**)		 : 10-11 External GSM modem power supply (*)
6				
7		: System alarm relay		 : USB external peripherals
8		: 7-8 No alarm		
9		: 7-9 Alarm present		
15		: Digital input (**)	 : COM port for external modem	
16			 : Telephone jack (only for internal modem)	
12 (-)		: RS 485	 : RJ45 LAN connector	
13 (+)				
14 (↓)				



position of the terminals on XWEB500D

LED

Led	Colour	Description
Alarm	Red	RS485 alarm
Rec	Blue	Data recording
Power	Green	System turned on
Status	Green	Messages are being sent
System	Red	System alarm
Alarm2	Red	Alarm relay 2 status (**)
Alarm1	Red	Alarm relay 1 status (**)

(*)= 12Vdc - 250mA. Compatible modem TC35-KIT (MC55i by Siemens, CINTERION L30960N2700A100),

Gatotel GT-HE910-EUD, Gatotel GT-HE910-NAD

(**)= For XWEB 500DIN only

NOTE: The status of the System LED depends on that of the relative "System alarm" relay.

NOTE: for XWEB300D, the AUX 'system relay' assumes the following logic:

- at rest (XWEB off) contacts 7 and 9 are closed
- in the event of an alarm, it closes at 7-8
- at start-up, it closes at 7-8 for a few seconds and, if there are no alarms, it returns to rest and closes at 7-9.

NOTE: The state of the LEDs ALARM 1 and 2 correspond to the state of ALARM CONTACTS 1 and 2 the following logic:

1. illuminated LEDs to shorted contacts
2. Led off to open contacts

In case of absent power, the contacts are normally open.

In the event of a powered system, the contacts are open or closed depending on the software configuration together with the alarm state.

NOTE: always use the power supply of the external modem of the same XWEB to guarantee the correct transmission of messages (e.g. SMS messages). Use the cord provided with KIT at terminals 10-11.

TERMINAL BLOCK (COOLMATE MODELS ONLY)

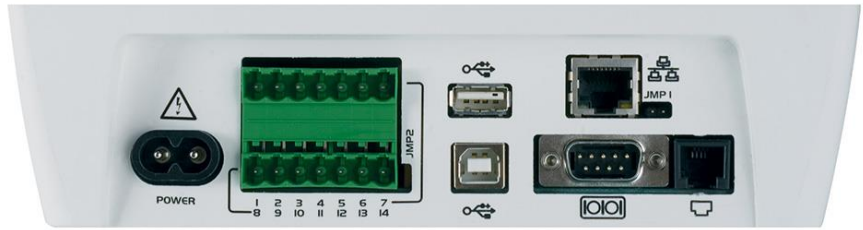

1		: Alarm relay 1
2		: Alarm relay 2
3		: Alarm relay 2
4		: Alarm relay 2
5		: System alarm relay
6		:5-6 No alarm
7		:5-7 Alarm present
8		: Modem reset relay
9		: Modem reset relay
10		: Digital input
11		: Digital input
12 (+)		: RS 485 socket
13 (-)		
14 (↓)		

	: Power supply connector
	: USB socket for PC connection
	: USB socket for devices connection
	: COM port for external modem
	: Telephone jack (only for internal modem)
	: RJ45 LAN connector

NOTE: for XWEB500, the 'reset modem' relay is energised for a reset every two minutes in the event of inactivity, and before each use (sending of a fax, dial-up, etc.). Add this relay to the power supply circuit of the external modem to guarantee the correct transmission of messages (e.g. SMS messages).

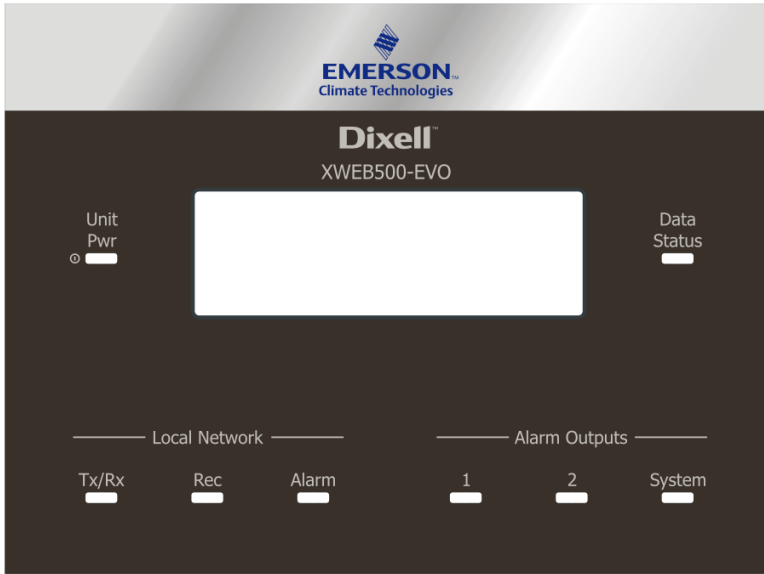

XWEB500

Led	Colore	Descrizione
Unit Pwr	Green	System turned on
Status	Green	Message / event queue in sending
Tx/Rx	Blue	Lit when the system performs operations on the serial line
Rec	Blue	System in data recording
Alarm	Red	Alarm present in the RS485 line
Alarm1	Red	Relay alarm 1
Alarm2	Red	Relay alarm 2
System	Red	System alarm

5. CONTROLLER INSTALLATION PROCEDURE

XWEB-EVO has an RS485 serial port to which the line of the controlling devices must be connected. Most Dixell controller devices are supplied with RS485 serial outputs, to connect the instrument to XWEB-EVO without requiring an external module or connecting cable. To check whether this feature is provided, read through the characteristics of the controller in the device manual. Nonetheless, some Dixell devices cannot be supplied with RS485 serial outputs directly but through small external converters: XJRS485 or XJ485. With this device it is possible to convert the output - of the controller - from 5-wire "TTL" to 2-wire "485". If you need to use the TTL/485 converter, be careful to:

- Keep the TTL cable away from any source of electromagnetic disturbance
- Connect each XJ485 module to the instrument by the TTL cable supplied with the module
- Mark the polarity of output 485, which needs to be observed when the instruments are connected to the network

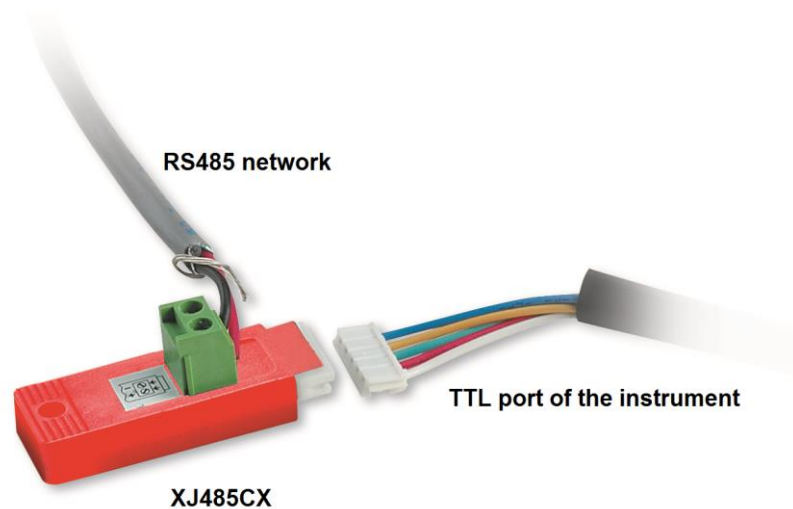

Below is a list of operational tips to achieve the best result in terms of reliability of the instrument network, with RS485 serial connection:

- The serial line cable can be 2-wire plus shielding, with a minimum section of 0.5 sq mm (ex. BELDEN 8772). This cable is recommended for its technical characteristics and because it maintains the quality of the electrical signal;
- The serial line cable must reach all of the instrument's stations: check the system's floor plan and the various distances that the cable needs to cover;
- The serial line cable can reach a maximum length of 1 km
- Match the polarity marked on the instrument with the polarity of the cable leading to the serial;

- Do not set up any branches on the line:

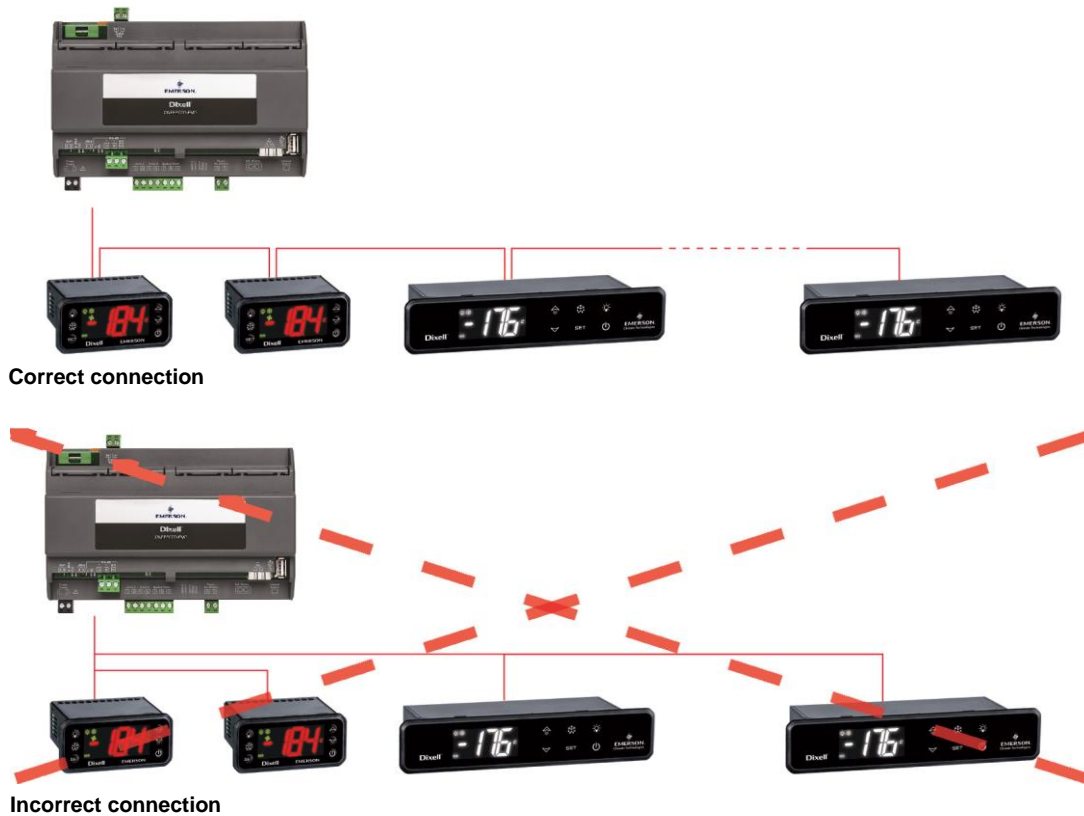

-
- Keep the serial cable away from power cables and from any possible source of electromagnetic disturbance
- Do not connect the serial cable shielding to the earth connection of the electrical system
- Do not connect the "Gnd" terminal.
- Draw a map of the installation that you are setting up: it may be useful in case of future problems or changes

5.1 CONTROLLER CONFIGURATION

On the same line, normally every controller is programmed with its own **unique serial address**, through the **Adr** parameter. Refer to the instrument's installation manual to learn about the access and editing procedures. For a simple description of the categories they belong to, organise address programming progressively. A number of special cases are listed in the pages below.

To keep the RS485 line balanced, a 120Ω terminating resistor must be fitted at the ends. If the XWEB is at one end of the RS485 line, it is advisable to fit the 120Ω terminating resistor on the last instrument and on XWEB. To enable the terminating resistor, insert the jumper in position 2 (JMP2 is marked on the unit). Do NOT insert the jumper if XWEB is at the centre of the RS485 line.

5.1.1 CONFIGURATION FOR XC400/600/800/900 AND XH200/300/400 SERIES

These instruments have two serial addresses and must be configured in the same way. Refer to the instrument's installation manual to learn about the access and editing procedures.

5.1.2 CONFIGURATION FOR XJA/XJP/XJM MODELS

XJA/XJP/XJM series instruments are configurable with one or more modbus addresses. Refer to their installation manual for the configuration procedures.

5.1.3 ENERGY METERS AND THIRD PARTY INSTRUMENT CONFIGURATION

For non-Dixell instruments, it will be necessary to configure the serial to work with baudrate 9600bps, 8bit, No Parity and 1 Stop bit (aka "9600,8,N,1). The use of another serial configuration may not be recognised by XWEB-EVO and this would lead to incorrect device operation.

To enter non-Dixell instruments, which are nonetheless required by the system, (for example the Carlo Gavazzi Energy Analyser), do the following:

- a. Enter "Menu→Devices Setup" and choose any instrument. To enter Energy Analyzer "WM22-DIN-AV5", select "ENERG.ANAL"
- b. Press "Add/Remove Device(s)". And, from the list, select the library for the device.
- c. Drag'n'Drop on 'Add Device(s)' and fill in the required information on the screen

All compatible Modbus devices have an RS 485 type output. Some compatible devices cannot be supplied with RS 485 serial outputs directly but through a small external converter that converts the output from 5-wire "TTL" to RS 485 (XJRS485 or XJ485). Make sure to check this feature according to the model of the device. Refer to the manual of the device for this purpose.

At the end, the RS 485 output should have 2 terminals with poles for setting up the network of the instruments to be monitored.

Follow these recommendations with care to ensure the efficiency of the network.

- The serial line cable must reach all of the stations where the instruments must be monitored.
- Note the correct polarity of the line.
- Program each instrument with its own address using the **Adr** parameter.

To set up installation of the system, we recommend having the following equipment available:

- a Phillips and a slot-head screwdriver;
- a PC with Ethernet port.

The system must be installed referring to the figure below, which illustrates the rear XWEB-EVO panel, and following the points listed here:

1. Attach the XWEB-EVO device in the position it will be used in.
3. Connect it to the power mains by the supplied power cord (1). Set the power plug up so that it is easily accessible at all times.
4. Connect the RS485, the relays and digital inputs, and end and/or polarise the line, if necessary;
5. Connect any telephone lines and/or LAN network cables;
9. Connect any internal or external modems (5), and the cable must not be any longer than 10 m.



For operator safety and to protect the XWEB system, before performing any sort of operation, connect the system to the electrical network by the supplied cable. Remove the power cord last.



- *Avoid direct passage between operators as much as possible (to avoid electrostatic induction and subsequent discharges);*
- *If the electrical voltage supply differs from the required rating, this could seriously damage the system;*
- *Connection errors (and connections that differ from the prescribed ones) can pose a danger to operator safety and cause faults in the system and to the instruments that are connected to it;*
- *Insert one or more easily accessible disconnecting devices to the exterior of the device to separate the device from the power mains;*
- *Do not use the device in environments with flammable gases.*
- *Do not modify the device in any way.*

Technical features	
Power supply	24V or 100-230V (DIN models) 230V ("COOLMATE" models)
Power	15VA Max (DIN models) 20VA Max ("COOLMATE" models)
Maximum voltage and current that can be applied to the AUX1-2-3 terminals.	24V
Operating conditions (temperature, humidity, special conditions)	T: 10-60°C R.H.20-85% (non-condensing) (DIN models) T: 0-60°C, R.H. 20-85% (non-condensing) ("COOLMATE" models)
Electrical safety (reference standards)	Standard EN 60950-1
Electromagnetic compatibility (reference standards)	Immunity EN 61000-6-2:2005 EN 55024:1998 + /A1:2001 +/A2:2003 EN 61000-4-2:2009 EN61000-4-3:2006 +/A1:2008 EN61000-4-4:2004 EN 61000-4-5:2006 EN 61000-4-6:2009 EN 61000 -4 -8:1993 +/ A1:2001 EN 61000-4-11:2004 Emissions EN 55022:2006+/A1:2007 EN 61000-3-2:2006 +/A1:2009 +/A2:2009 EN 61000-3-3 :2008
Maximum current to the USB device	200 mA

Internal modem: list of supported countries			
Argentina	France	Latvia	Russia
Australia	Germany	Liechtenstein	Singapore
Austria	Greece	Lithuania	Slovak Republic
Belgium	Hong Kong, S.A.R.of China	Luxembourg	Slovenia
Brazil	Hungary	Malaysia	South Africa
Canada	Iceland	Malta	Spain
Chile	India	Mexico	Sweden
China	Indonesia	Netherlands	Switzerland
Cyprus	Ireland	New Zealand	Taiwan
Czech Republic	Israel	Norway	Thailand
Denmark	Italy	Philippines	Turkey
Estonia	Japan	Poland	United Kingdom
Finland	Korea	Portugal	United States

CAUTION:



The terminal block to connect AUX1, AUX2 and AUX3 relays cannot be used to pilot high voltage loads directly (higher than 24V). Use an intermediate low voltage circuit and/or suitable remote switch.

LED

Led	Colour	Description
Pwr	Green	On when the system is powered
HDD	Blue	On when the disc executes physical writing operations
Rec	Blue	On when the system is recording data
Ser1/Ser2	Blue	On when the system is reading and/or writing on serial port 485
Mdm	Blue	On when the system runs operations with the analogue modem
DI1/DI2	Blue	On when the system detects the digital input as being active
Aux1/Aux2/Aux3	Blue	On when the system sets the relay output as active
Alarm	Red	On when the system detects an alarm

If you intend to use external peripheral devices, always connect them to the unit before turning it on. Caution: always and only connect the external peripheral devices before turning on XWEB-EVO. If necessary, consult the instructions manual for the individual connected device.

When the system has been launched, the home page will appear (also known as the login page). Enter user name and password to login.

Note that the user interface for the connection is always the same, regardless of what type of access has been set up: local PC, Intranet or Internet.

6. REMOTE CONNECTIVITY



The XWEB-EVO user or installer can access his/her user interface from the screen and keyboard only for XWEB500 COOLMATE. For all models, use a web interface from a PC which must be connected and configured to communicate with the XWEB network via an Ethernet port.

Using a PC as an interface terminal provides better performance than local connectivity, we therefore recommend it, especially for initial configuration.



The PC that you wish to use for the connection must fulfil and support the minimum characteristics for installation and use:

6.1 DESKTOP

Browser	Support	Minimum Version
Microsoft Internet Explorer (IE)	NOT SUPPORTED	
Microsoft Edge	SUPPORTED	12+
Mozilla Firefox	SUPPORTED	28+
Google Chrome	SUPPORTED	29+
Apple Safari	SUPPORTED	9+
Opera	SUPPORTED	17+

6.2 MOBILE

Browser	Support	Minimum Version
Apple iOS Safari	SUPPORTED	9+
Android Stock	SUPPORTED	4.4+
Android Google Chrome	SUPPORTED	29+
Android Mozilla Firefox	SUPPORTED	28+

In the following sections, general information is provided on the possible network configurations, suitable for connection between XWEB-EVO and your computer. From the start we recommend following the advice of an IT expert and/or your network administrator to assess which configurations are most suited to your needs. Antivirus, firewall and toolbar software (for example YAHOO and/or GOOGLE) can impede you from viewing XWEB-EVO pages correctly. We recommend checking the configuration of this software and adding their XWEB-EVO IP addresses to the list of safe sites. With firewalls, make sure that ports 80 and 22 are mapped towards XWEB-EVO so that it can be reached from outside..

6.3 CONNECTIVITY WITH CROSS CABLE

Local access from the PC is the fastest way to manage setup. It is possible to connect a PC to XWEB-EVO through the network interface supplied with an 'RJ45 Ethernet connector'. The connection between the two must be set up using a cross network cable (aka 'cross cable'). This cable is available at any computer store.

Once the physical connection has been set up, launch the browser on your PC and enter the following in the address bar <http://192.168.0.150> (XWEB-EVO default address). The connection procedure is complete when the login page opens up. Enter user name and password to start using your XWEB-EVO.

Caution: a pre-requisite to setting the connection up correctly is that the XWEB-EVO address and network interface address on your PC need to have a compatible IP class. For example, with an XWEB-EVO network interface configured with 192.168.0.200, the network interface on your PC can be configured with 192.168.0.15

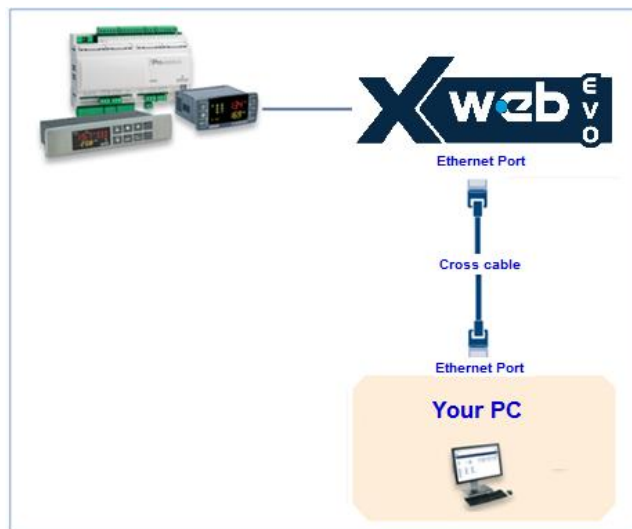

To configure the network interface of your PC, it is normally necessary to access the administrator level. Refer to the documents for your computer's operating system. The figure below illustrates the steps that need to be taken to configure a network interface on a computer with WINDOWS 7

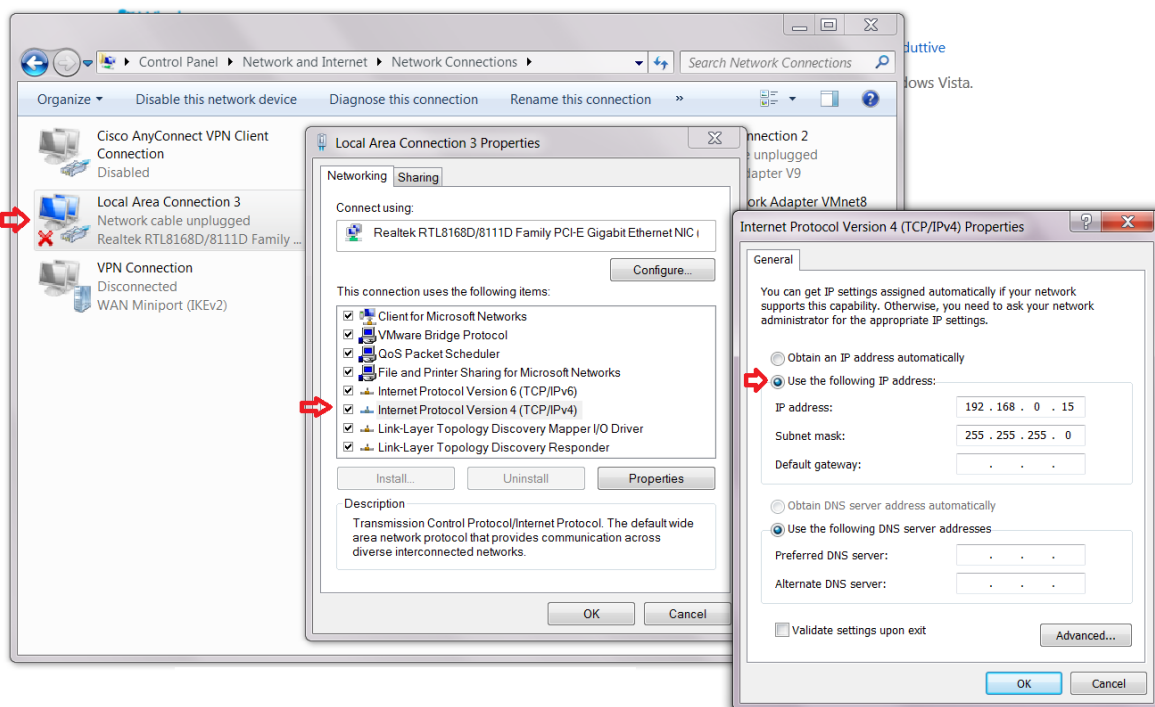

6.4 MODEM CONNECTIVITY (“OR POINT-TO-POINT CONNECTION”)

A modem connection makes it possible to set up a connection between PC and XWEB-EVO through the phone line. This type of connection is usually required when there is no internet connection available on the local LAN line. An analogue phone line is required (not ISDN), which we recommend setting up exclusively for XWEB-EVO use.

Caution: only use the supplied modem or a Dixell-recommended one. The supported external modems are: 230/100 or 24V XWEBMODEM.

Do not buy any type of modem other than the listed ones. Dixell cannot be held responsible for any damage caused by the use of non-recommended modems. Connect the modem to the serial port on the back of the unit, using the cable supplied with the modem. Connect the modem to the telephone line using the cable supplied by the manufacturer. Be careful of any telephone switchboard to access the external line.

The connection procedure is divided into two parts:

6.4.1 SETTING UP THE REMOTE ACCESS CONNECTION

The configuration of your PC includes the creation of a "remote access" connection. The illustrations below mark the steps that need to be carried out to complete the procedure to set up a remote access connection with WINDOWS 7.

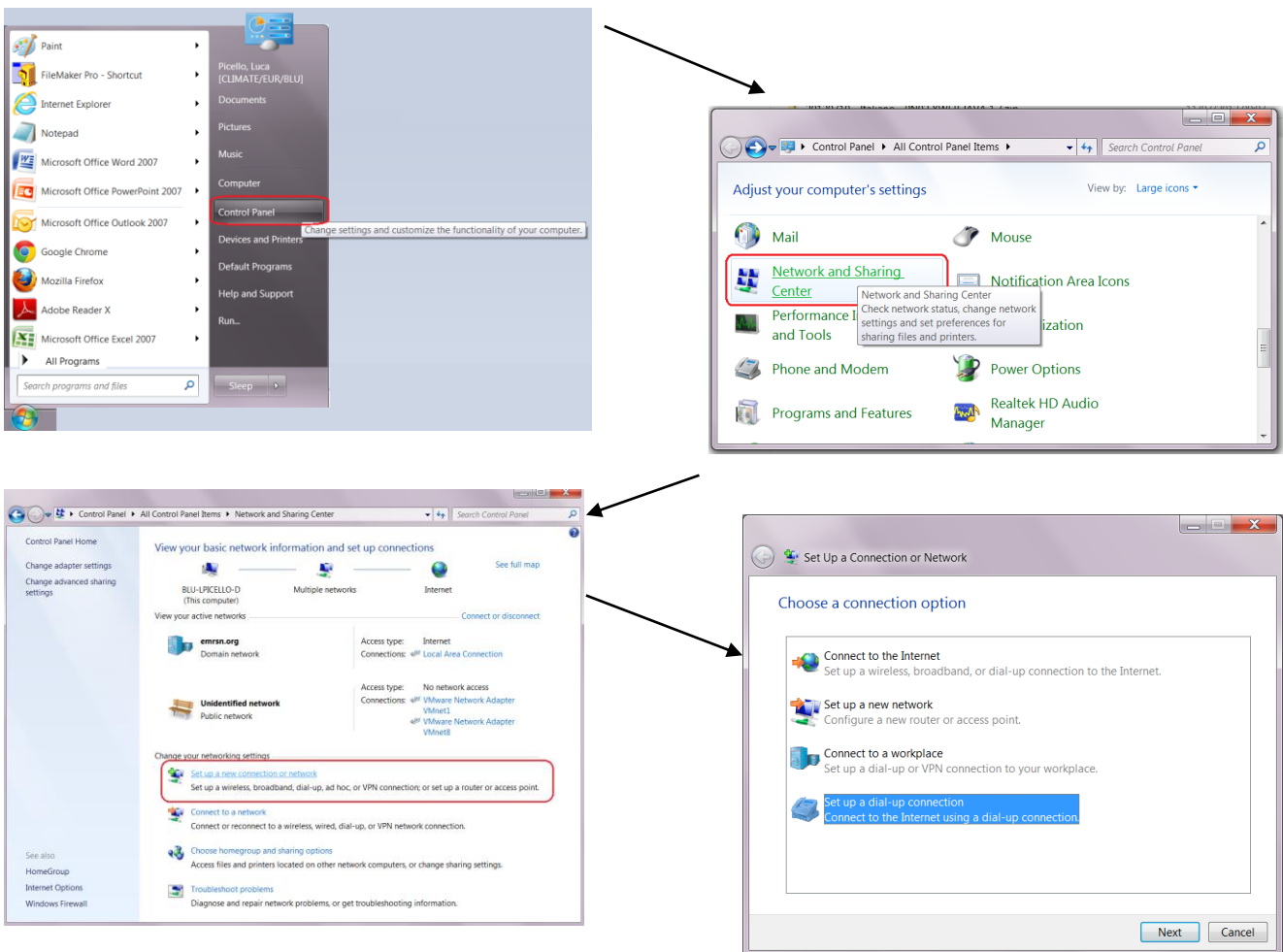

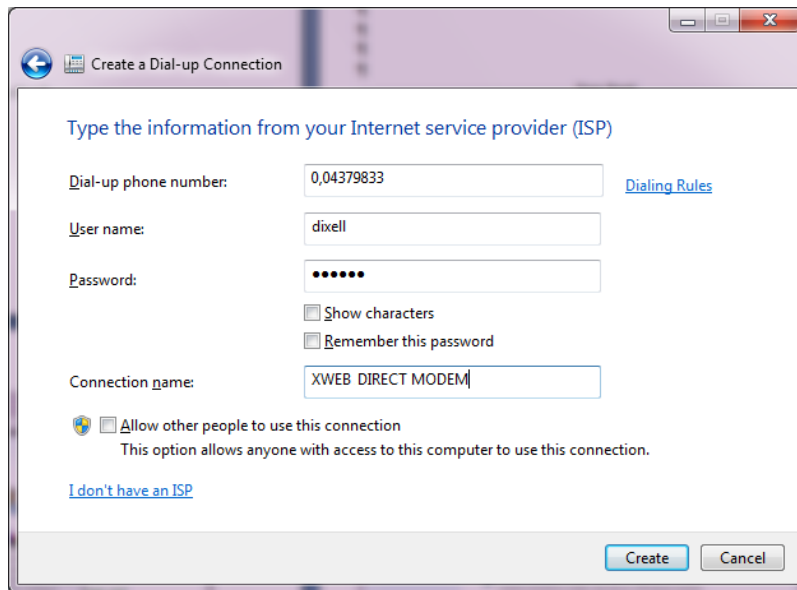

Enter the telephone number of the line that XWEB-EVO is connected to. If there is a switchboard and the number that needs to be dialled for the external line is 0, enter: 0,04379833. Enter 'dixell' as the user name and password connection parameters. Enter a name to identify the XWEB-EVO that you wish to contact with the call.

6.4.2 MAKING THE REMOTE ACCESS CALL

When the configuration step is finished, set up the call to XWEB as illustrated in the pictures below, which represent the calling procedure for computers with WINDOWS 7.

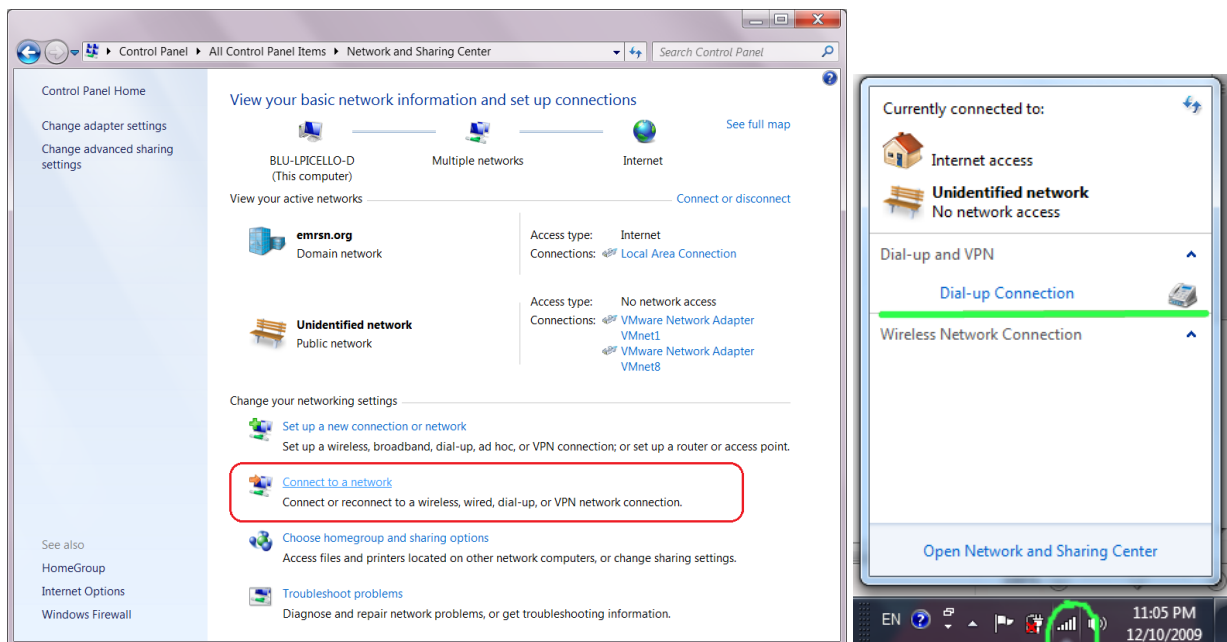

When the connection has been set up between your PC and XWEBEVO, use your browser to access <http://192.168.1.150> . When the login page opens correctly, this means that the execution test of the entire procedure is complete.

6.5 INTRANET (“OR LAN CONNECTION”) AND VPN CONNECTIVITY

This type of connection allows you to access XWEB-EVO from any PC connected to the local network. This type of connection must also be used to configure XWEB-EVO for internet connection through VPN (Virtual Private Network). This last type of connection, once it has been set up, makes your PC -- connected to the internet -- part of the local XWEB-EVO network.

Caution: your company's connection to the local network needs to be managed by qualified staff and/or a network administrator. If you wish to use a VPN network for access, this person must be able to assign a valid IP address to XWEB-EVO and provide -- for your PC -- any software and credentials.

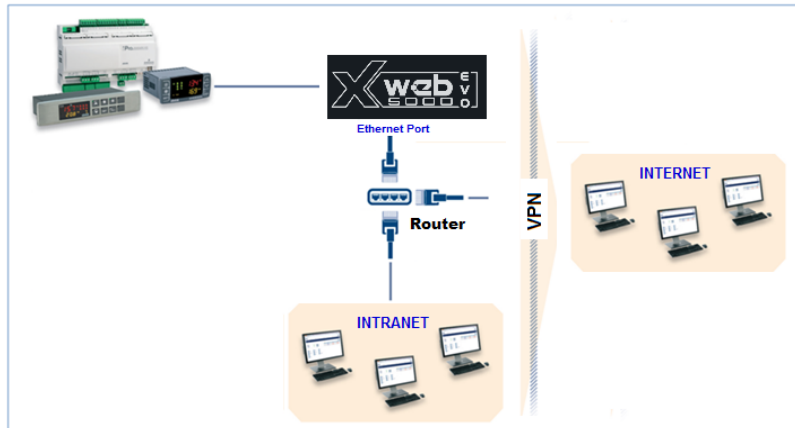

Before connecting XWEB-EVO to the network, make sure that the IP address you wish to use for XWEB-EVO has not already been claimed and can therefore be used. You can run a PING on that address, and if you receive at least one reply the address needs to be changed, as this means it is already in use.

Example:

```
C:\Windows\system32\cmd.exe

C:\>ping 10.100.82.201 ← command to verify the IP address

Pinging 10.100.82.201 with 32 bytes of data:
Reply from 10.100.82.201: bytes=32 time=34ms TTL=62
Reply from 10.100.82.201: bytes=32 time<1ms TTL=62
Reply from 10.100.82.201: bytes=32 time<1ms TTL=62
Reply from 10.100.82.201: bytes=32 time<1ms TTL=62
Ping statistics for 10.100.82.201:
    Packets: Sent = 4, Received = 4, Lost = 0 (0% loss),
    Approximate round trip times in milli-seconds:
        Minimum = 0ms, Maximum = 34ms, Average = 8ms

C:\>_
```

with a reply the IP address is already used, you need to set up your new xweb with another IP address !

Another way of finding out what IP addresses are already in use on a line is using the ARP control. We recommend reading the documents relative to the operating system that you are using and/or seek the assistance of qualified staff for network configuration.

Before connecting XWEB-EVO to the network, please configure the IP (and the other network configuration parameters) using the direct local connection (with screen, keyboard and mouse) or the local PC connection with cross cable. When the network parameters are set, it is possible to connect XWEB-EVO to the local network using a standard RJ45 cable. Connect your PC to XWEB-EVO by opening your browser and entering the XWEB-EVO IP address in the address bar. <http://192.168.0.200/> The default address is: Save this address in your list of favourites.

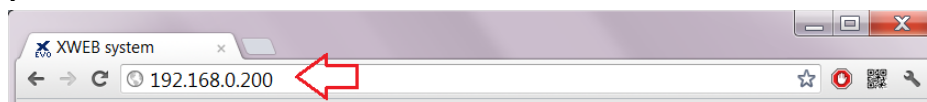

6.6 INTERNET CONNECTIVITY ON PUBLIC IP

This type of connection allows you to access XWEB directly from any PC with an internet connection without having to install any additional software on your PC.



Caution: the Internet connection needs to be managed by qualified staff and/or a network administrator.



To connect your XWEBEVO to the Internet **you will need a 'public and static IP address'**, which **needs to be given to you by your ISP** (Internet Service Provider). Tell your ISP that you wish to install a web server: this will help your provider understand your requirements and provide you with a suitable connection. We strongly recommend asking for all of the connection contract details to deal with any future connection problems.

It is possible to set up an internet connection when there is a router. Router configuration, as well as XWEBEVO, depends on the data given to you by your ISP. Depending on the type of contract, the provider can supply the Router or the customer can purchase one separately.

For the first configuration it may be necessary to use a direct local connection (with screen, mouse and keyboard) or a local connection from your PC (with cross cable) or LAN line.

Provide your XWEBEVO ports (LAN side) to your ISP and/or network administrator.

- 80 (used for HTTP access)
- 22 (used for SSH access)

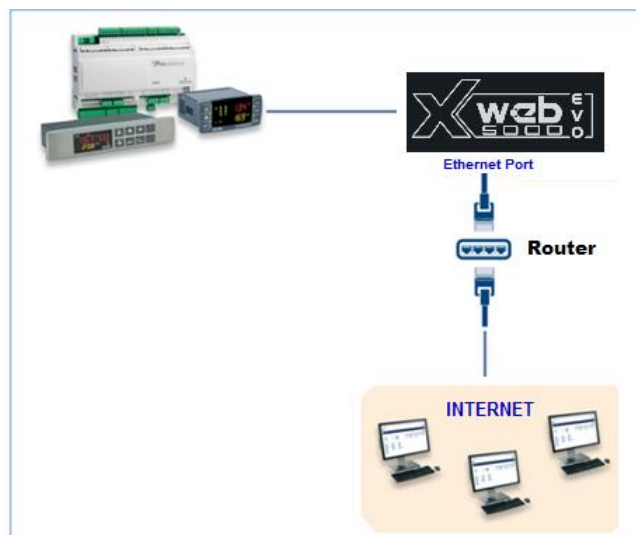

7. EMERGENCY PROCEDURE

This procedure is to restore XWEB parameters to factory default values; it is useful in cases where the IP address and / or the web service port and / or access credentials (username / password) have been lost and / or if generic errors occurs. This procedure is applicable with XWEB of software versions 5.0 and above.

- 1) With the instrument switched off, close the "JMP1" contacts using a jumper supplied with the XWEB product



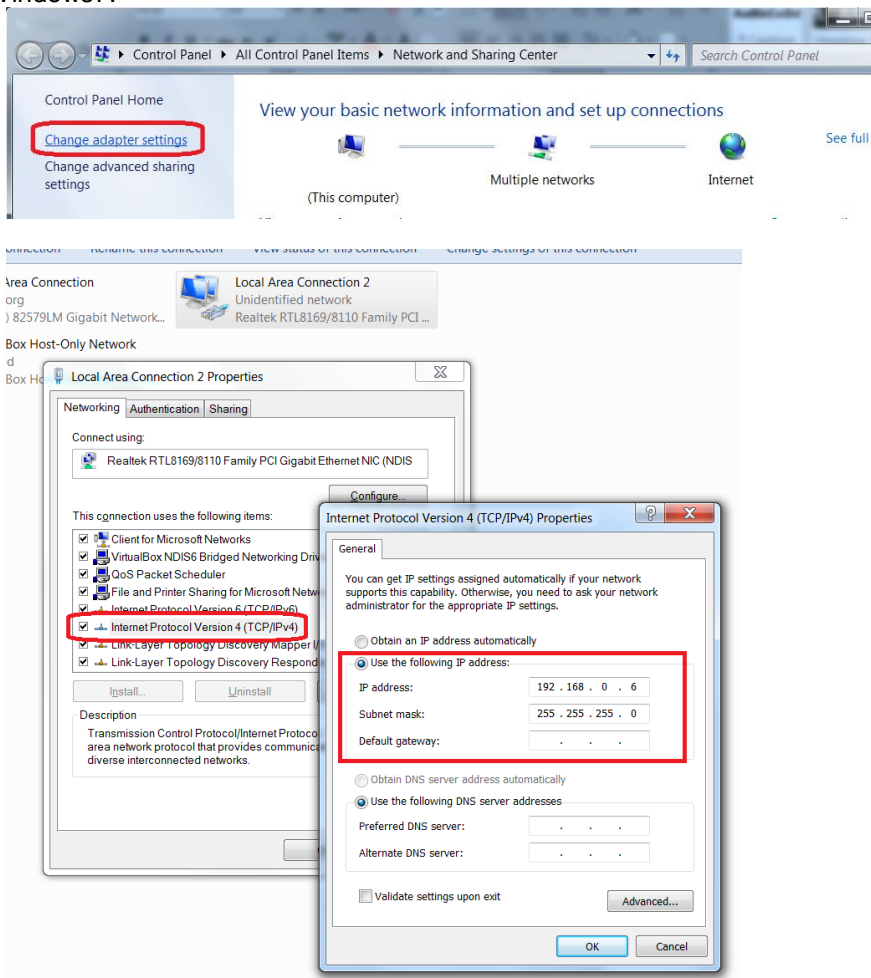

- 2) Connect a network cable between XWEB and PC
- 3) Configure the network interface of the PC with address 192.168.0.6 or compatible class

in Windows7:



4) Power on XWEB and wait a couple of minutes

5) Open with your browser (Firefox  or Chrome ) the address <http://192.168.0.150>

A page like the one below will be presented in which will be present:

- a. **MAC Address:** XWEB alphanumeric identification code
- b. **IP Address:** IP address functioning outside the emergency procedure
- c. **HTTP / HTTPS Port:** web service ports operating outside the emergency procedure
- d. **DATE:** system date

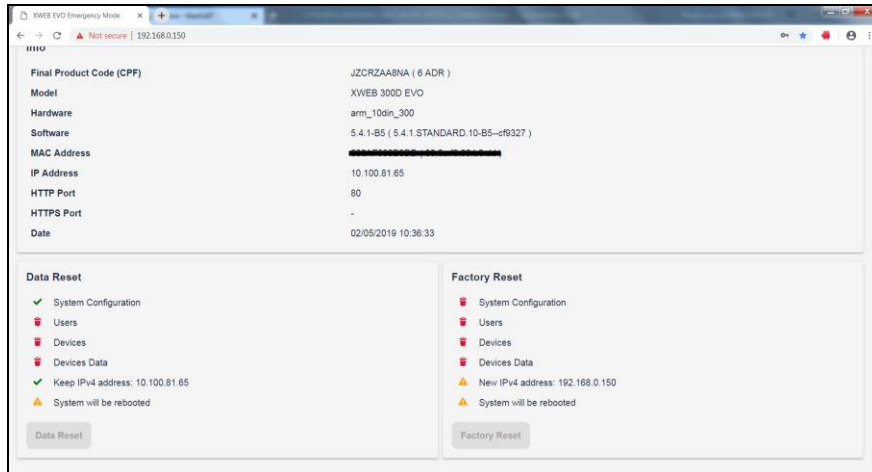

If you only want to recover the IP you can interrupt the procedure now by opening the JMP1 contacts and restarting XWEB by acting on its power supply.

To complete the emergency procedure and reset the user configuration and the configured field devices, proceed with the operations described below. Warning: all historical data (such as temperatures) will also be lost; software updates and / or libraries will remain installed. The reset operation is not reversible, and the lost data will not be recoverable by XWEB.

6) Press on FACTORY RESET to reset the system parameters including the network configuration; with this option the system will become reachable outside the emergency procedure only on IP:192.168.0.150; press on DATA RESET to avoid losing the network configuration (and the other system configuration parameters); the system will then be reachable outside the emergency procedure with the IP of "IP ADDRESS" present on the page described in the previous section.

7) Open the JMP1 contacts by disconnecting the jumper

8) Enter the credentials provided by Dixell Technical Support; the data of MAC ADDRESS and DATE must be provided beforehand:

9) Press the "Confirm" key: if the data entered are correct the system will complete its operations and will be restarted automatically. Warning: do not disconnect the power supply until XWEB completely restarts.

10) Wait a couple of minutes to complete the operation and the emergency procedure; it will now be possible to log in with a username and password: Admin / Admin

8. OPERATION

For operating procedures, please refer to the OPERATING MANUAL in “Product Literature” section of <http://www.dixell.com> where you can find the updated version.

9. SYSTEM DATA

Fill in the table below, make a xerox copy and keep it near the XWEB.

HostName _____ [example: myXWEB001]

IP Address _____ [example: 192.168.0.123]

Gateway _____ [example: 192.168.0.1]

DNS _____ [example: 8.8.8.8]

SMTP _____ [example: 192.168.0.14]

E-mail Address _____ [example: myXWEB001@company.com]

Modem _____

Telephone number _____

10. TRADEMARKS

Consider It Solved and Intelligent Store are trademarks and Emerson Climate Technologies and the Emerson Climate Technologies logo are service marks and trademarks of Emerson Electric Co. Windows and Internet Explorer are registered trademarks of Microsoft Corporation in the United States and other countries.

Oracle and Java are registered trademarks of Oracle and/or its affiliates.

Google is a registered trademark of Google Inc.

Firefox is a registered trademark of the Mozilla Foundation.

Yahoo! is a registered trademark of Yahoo! Inc.

Linux is a trademark registered to Linus Torvalds.

Other names may be trademarks of their respective owners.

